

Quick reference guide

Kurzanleitung

Guide de référence rapide

Beknopte bedieningsgids

Guida di riferimento rapido

Guía de referencia rápida

Guia de referência rápida

Краткий справочник



Refer to the operation manual for detailed instruction.

Also, there are differences in the keys and screens depending on the display language. In this guide, English screens are used for basic explanations.

Einzelheiten entnehmen Sie bitte der Bedienungsanleitung.

Je nachdem, welche Sprache für die Bildschirmanzeigen gewählt wurde, ergeben sich im Hinblick auf Bildschirmbilder eventuell Unterschiede. Die grundlegende Bedienung der Maschine ist in dieser Anleitung am Beispiel von Bildschirmbildern mit englischem Text erklärt.

Pour les instructions détaillées, voir le mode d'emploi.

Par ailleurs, il y a des différences dans les touches et les écrans en fonction de la langue d'affichage. Dans ce guide, les explications de base utilisent les écrans anglais.

Zie de gebruiksaanwijzing voor gedetailleerde instructies.

Er zijn verschillen in de toetsen en schermen afhankelijk van de ingestelde taal. In de beschrijvingen in deze beknopte handleiding worden de Engelse schermen gebruikt.

Fare riferimento al manuale di impiego per istruzioni dettagliate.

Inoltre, ci sono differenze nei tasti e nelle schermate a seconda della lingua visualizzata. In questa guida, le schermate in inglese sono usate per le spiegazioni basilari.

Consulte el manual de instrucciones para ver más detalles.

Además, dependiendo del idioma visualizado algunos botones y pantallas podrán ser diferentes. En esta guía, para las explicaciones básicas se emplean pantallas en inglés.

Consulte o manual de operação para saber as instruções detalhadas.

Além disso, há diferenças nas teclas e telas dependendo do idioma de exibição. Neste guia, as telas em inglês são usadas para as explicações básicas.

Более подробная информация представлена в руководстве по эксплуатации.

Кроме того, в зависимости от языка сообщений на ЖК-дисплее названия кнопок и другая информация на экранах могут иметь некоторые различия. В настоящем справочнике основные пояснения даются на примере экранов с информацией на английском языке.

<English display>
<Englische Anzeige>
<Affichage en anglais>
<Engels scherm>
<Schermata in inglese>
<Visualización en inglés>
<Display em inglês>
<Экран: английский язык>

<Example: German>
<Beispiel: Deutsch>
<Exemple : allemand>
<Voorbeeld: Duits>
<Esempio: Tedesco>
<Ejemplo: Alemán>
<Exemplo: alemão>
<Пример: немецкий язык>



Copyright, Zündt Design 2012, All rights reserved.

All artwork and designs created by Zündt Design Ltd are copyrighted. The embroidery data you obtain from zundtdesign.com and Zündt Design Ltd is licensed for customer use only.

Copyright, Zündt Design 2012, Tous droits réservés.

Tous les travaux et motifs créés par Zündt Design Ltd sont protégés par le droit d'auteur. Les motifs de broderie obtenus de zundtdesign.com et de Zündt Design Ltd ne peuvent être utilisés qu'à titre privé.

Copyright, Zündt Design 2012, tutti i diritti riservati.

Tutte le illustrazioni e i disegni creati da Zündt Design Ltd sono protetti da copyright. I disegni da ricamo ottenuti da zundtdesign.com e Zündt Design Ltd sono concessi in licenza esclusivamente per l'uso da parte dei clienti.

Direitos autorais, Zündt Design 2012. Todos os direitos reservados.

Todas as obras de arte e desenhos criados por Zündt Design Ltd estão protegidos por direitos autorais. Todos os padrões de bordado obtidos de zundtdesign.com e Zündt Design Ltd são licenciados para uso somente do cliente.

Copyright, Zündt Design 2012, Alle Rechte vorbehalten.

Alle von Zündt Design Ltd erstellte Vorlagen und Designs sind urheberrechtlich geschützt. Die über zundtdesign.com und bei Zündt Design Ltd erhältlichen Stickmuster sind nur für den privaten Gebrauch lizenziert.

Copyright, Zündt Design 2012, Alle rechten voorbehouden.

Alle tekeningen en ontwerpen die zijn gemaakt door Zündt Design Ltd vallen onder copyright. Borduurpatronen die u verkrijgt op zundtdesign.com en Zündt Design Ltd mogen uitsluitend door u als klant worden gebruikt.

Copyright, Zündt Design 2012, Todos los derechos reservados.

Todas las ilustraciones y diseños han sido creados por Zündt Design Ltd, que posee los derechos de autor. Los patrones de bordado disponibles en zundtdesign.com o en Zündt Design Ltd sólo están autorizados para su uso por parte del cliente.

© Zündt Design, 2012. Все права защищены.

Все декоративные элементы и композиции, созданные компанией Zündt Design Ltd., защищены авторским правом. Рисунки вышивания, полученные вами с веб-сайта zundtdesign.com или от компании Zündt Design Ltd., лицензированы только для личного использования.

Contents

Winding the Bobbin	2
Setting the Bobbin	4
Upper Threading	5
Preparing to Embroider	6
Selecting Stitch Patterns	8
Summary of Stitch Patterns	12
Embroidery Pattern Color Change Table	21
Examples of Combinations	42
Color Thread Conversion Chart	47

Table des matières

Bobinage de la canette	2
Mise en place de la canette	4
Enfilage supérieur	5
Préparation de la broderie	6
Sélection des configurations de point	8
Sommaire des motifs de point	12
Tableau de changement de couleur des motifs de broderie	21
Exemples de combinaisons	42
Tableau de conversion des fils de couleur	47

Sommario

Avvolgimento della spolina	2
Impostazione della spolina	4
Infilatura superiore	5
Preparativi per il ricamo	6
Selezione degli schemi punto	8
Sommario degli schemi punto	12
Tabella di cambiamento colori degli schemi di ricamo	21
Esempi di combinazioni	42
Tabella di conversione dei fili colorati	47

Índice

Enrolando a bobina	2
Regulando a bobina	4
Como passar a linha superior	5
Preparando para bordar	6
Selecionando padrões de pontos	8
Resumo de padrões de pontos	12
Tabela de alteração de cor do padrão de bordado	21
Exemplos de combinações	42
Tabela de conversão das cores de linha	47

Inhalt

Aufspulen des Unterfadens	2
Einsetzen der Spule	4
Einfädeln des Oberfadens	5
Vorbereitung zum Sticken	6
Wahl des Stickmusters	8
Stickmuster-Übersicht	12
Stickmuster-Farbtabelle	21
Kombinationsbeispiele	42
Stickgarn-Farbtabelle	47

Inhoudsopgave

Spoel opwinden	2
Aanbrengen van het spoeltje	4
Inrijgen van de bovendraad	5
Vorbereidingen voor borduren	6
Kiezen van de steekpatronen	8
Overzicht van de steekpatronen	12
Kleurwijzigingstabel voor de borduurpatronen	21
Voorbeelden van combinaties	42
Omzettingstabel voor kleurgaren	47

Contenido

Devanado de la bobina	2
Colocación de la bobina	4
Hilo superior	5
Preparativos para bordar	6
Selección de tipos de puntada	8
Resumen de tipos de puntada	12
Tabla de cambio de color para patrones de bordado	21
Ejemplos de combinaciones	42
Tabla de conversión de hilos de color	47

Содержание

Намотка шпульки	2
Установка шпульки	4
Заправка верхней нити	5
Подготовка к вышиванию	6
Выбор рисунков для вышивания	8
Образцы рисунков для вышивания	12
Таблицы цветов нитей для вышивок	21
Примеры комбинирования	42
Таблица преобразования цветов нитей	47

Winding the Bobbin

Bobinage de la canette

Avvolgimento della spolina

Enrolando a bobina

Aufspulen des Unterfadens

Spoel opwinden

Devanado de la bobina

Намотка шпульки

Follow the numbered steps below in order. Refer to the operation manual for detailed instruction.

Führen Sie die folgenden Schritte in der angegebenen Reihenfolge aus. Ausführliche Hinweise finden Sie in der Bedienungsanleitung.

Suivez les étapes numérotées ci-dessous dans l'ordre. Consultez le manuel d'instructions pour des procédures détaillées.

Voer de genummerde stappen uit in de juiste volgorde. Uitvoerige aanwijzingen vindt u in de bedieningshandleiding.

Seguire i passaggi numerati nell'ordine riportato di seguito. Fare riferimento al manuale d'istruzioni per le istruzioni dettagliate.

Realice los siguientes pasos numerados en el orden indicado. Para obtener instrucciones detalladas, consulte el manual de instrucciones.

Siga os passos numerados a seguir em ordem. Consulte o manual de operação para saber as instruções detalhadas.

Выполните приведенные ниже операции в порядке их нумерации. Более подробная информация представлена в руководстве по эксплуатации.

Use only the enclosed bobbin or bobbins of the same type.

Verwenden Sie nur die im Lieferumfang enthaltene Spule oder Spulen vom selben Typ.

N'utilisez que la canette fournie ou des canettes du même type.

Gebruik alleen de bijgeleverde spoel of spoelen van hetzelfde type.

Utilizzare solo la spolina inclusa o spoline dello stesso tipo.

Utilice sólo la bobina incluida o bobinas del mismo tipo.

Use somente a bobina inclusa ou bobinas do mesmo tipo.

Применяйте только прилагаемые к машине шпульки или шпульки того же типа.

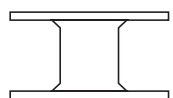

11.5 mm (approx. 7/16 inch)

(ca. 7/16 Zoll)

(env. 7/16 po)

11,5 mm (ca. 7/16 inch)

(circa 7/16 in.)

(aprox. 7/16 pulg.)

(aprox. 7/16 pol.)

(прим. 7/16 дюйма)

◆ Using the Supplemental Spool Pin

You can wind the bobbin during sewing.

◆ Utilisation du porte-bobine supplémentaire

Vous pouvez bobiner la canette pendant la couture.

◆ Utilizzo del portarocchetto supplementare

È possibile avvolgere la spolina durante la cucitura.

◆ Usando o pino do carretel complementar

Você pode enrolar a bobina durante a costura.

◆ Verwendung des zusätzlichen Garnrollenstifts

Sie können den Unterfaden während des Nähens aufspulen.

◆ Gebruik van de klospen

U kunt de spoel opwinden tijdens het naaien.

◆ Uso del portacarrete suplementario

Puede devanar la bobina mientras está cosiendo.

◆ Использование дополнительного стержня для катушки

Можно наматывать нить на шпульку во время шитья.

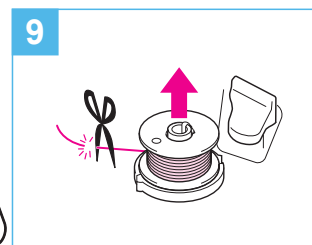
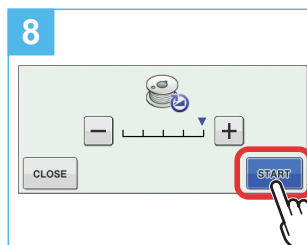
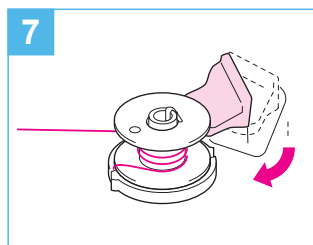
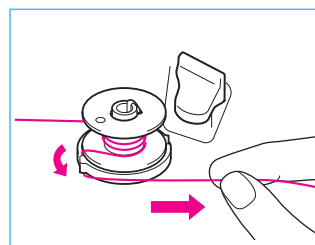
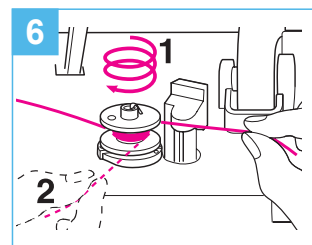
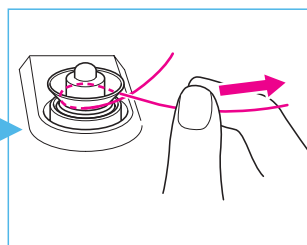
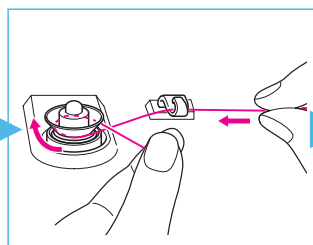
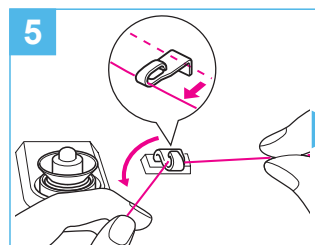
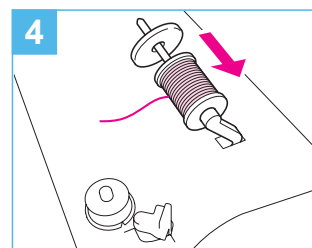
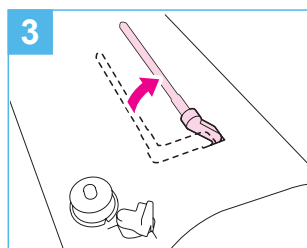
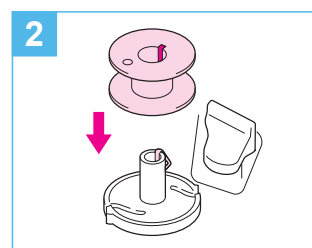
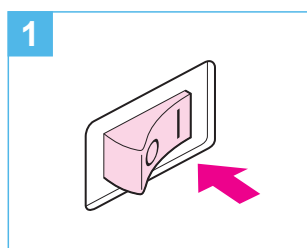
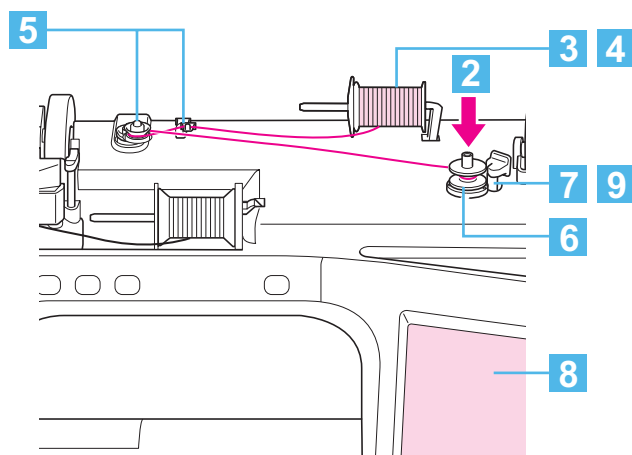

◆ Using the Spool Pin

You can use the main spool pin to wind the bobbin before sewing.

◆ Utilisation du porte-bobine

Vous pouvez bobiner la canette avant de coudre à l'aide du porte-bobine principal.

◆ Utilizzo del portarocchetto

È possibile utilizzare il portarocchetto principale per avvolgere la spolina prima di cucire.

◆ Usando o pino do carretel

Você pode usar o pino do carretel principal para enrolar a bobina antes de costurar.

◆ Verwendung des Garnrollenstifts

Mit dem Hauptgarnrollenstift können Sie vor dem Nähen den Unterfaden aufspulen.

◆ Gebruik van de klospen

Voordat u gaat naaien kunt u met de hoofdklospen de spoel opwinden.

◆ Uso del portacarrete

Puede utilizar el portacarrete principal para devanar la bobina antes de coser.

◆ Использование основного стержня для катушки

Для намотки шпульки перед шитьем можно использовать главный стержень для катушки.

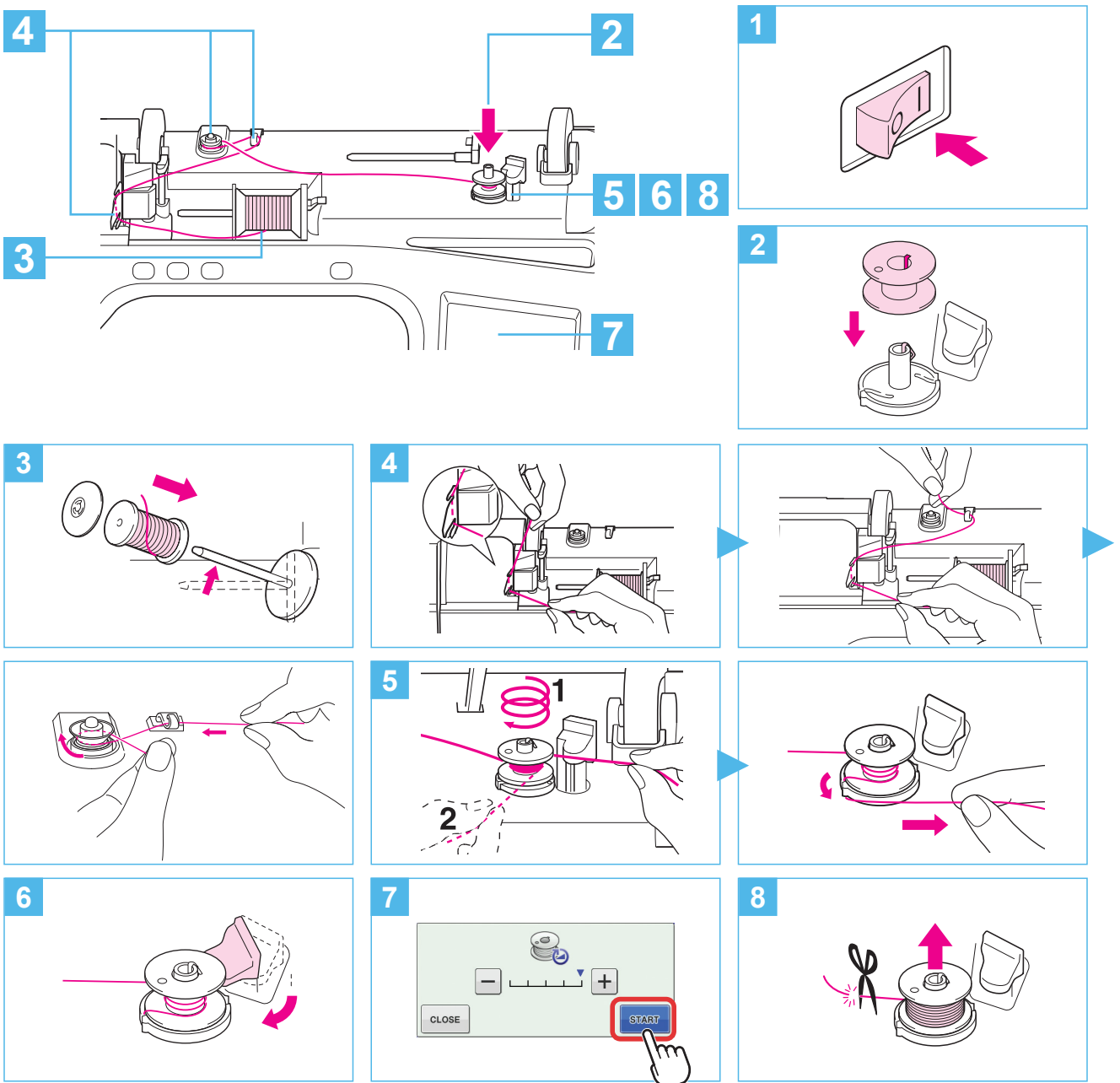

Setting the Bobbin

Mise en place de la canette

Impostazione della spolina

Regulando a bobina

Einsetzen der Spule

Aanbrengen van het spoeltje

Colocación de la bobina

Установка шпульки

Refer to the operation manual for detailed instruction.
Pour les instructions détaillées, voir le mode d'emploi.
Fare riferimento al manuale di impiego per istruzioni dettagliate.
Consulte o manual de operação para saber as instruções detalhadas.

Einzelheiten hierzu entnehmen Sie bitte der Bedienungsanleitung.
Zie de gebruiksaanwijzing voor gedetailleerde instructies.
Consulte el manual de instrucciones para ver más detalles.
Подробная информация: см. в руководстве по эксплуатации

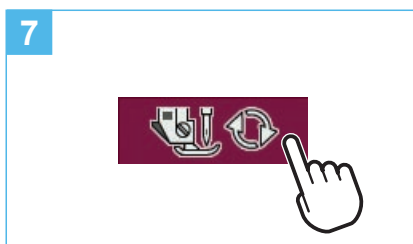
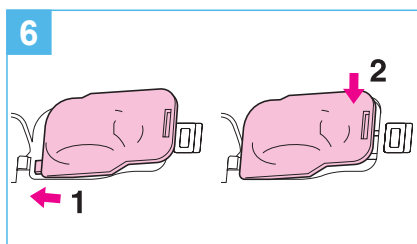
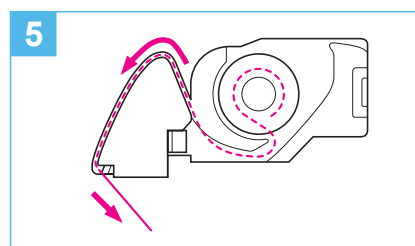
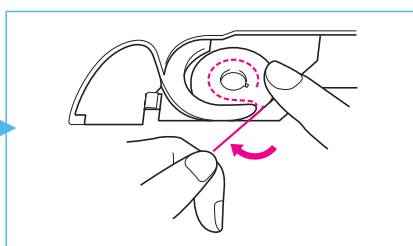
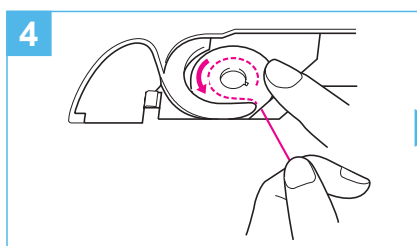
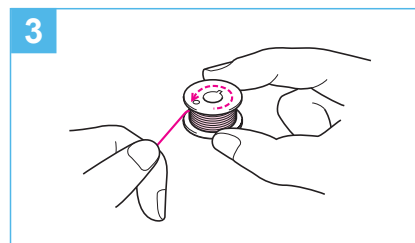
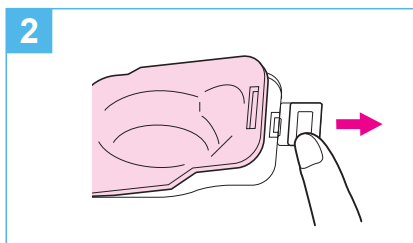

Upper Threading
Enfilage supérieur
Infilatura superiore
Como passar a linha superior

Einfädeln des Oberfadens
Inrijgen van de bovendraad
Hilo superior
Заправка верхней нити

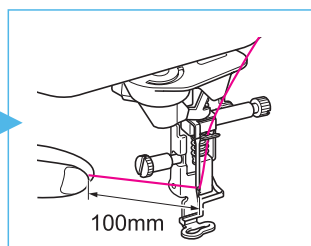
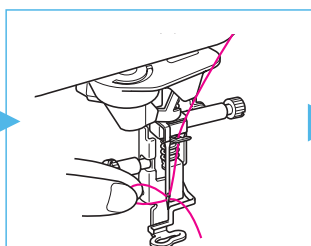
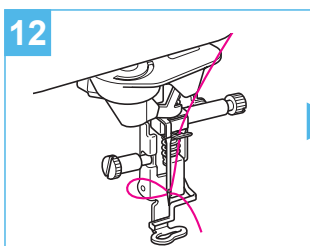
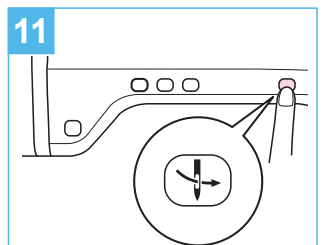
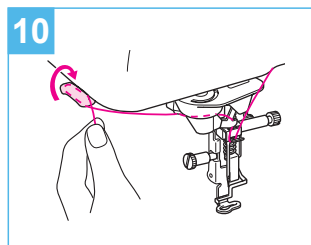
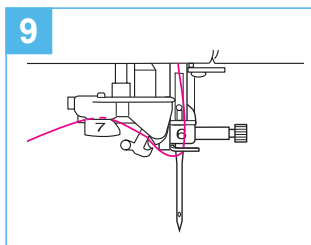
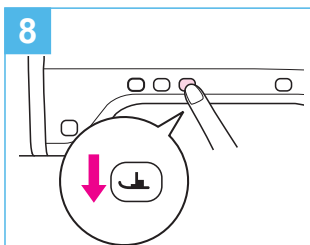
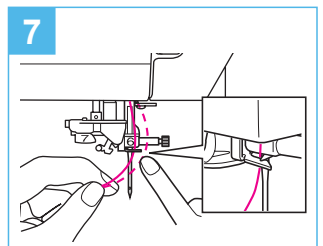
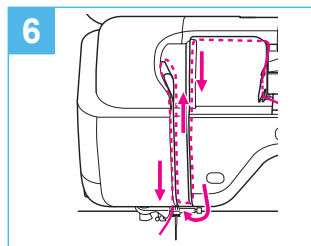
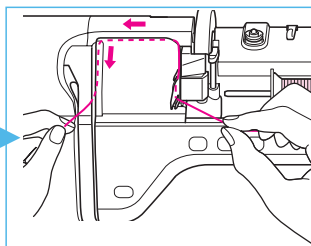
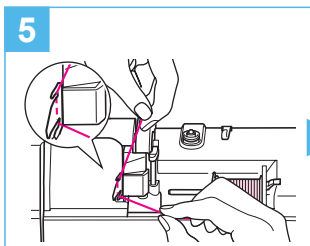
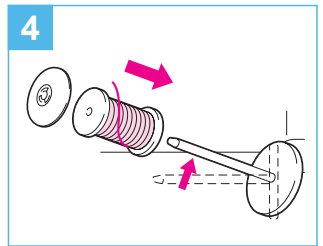
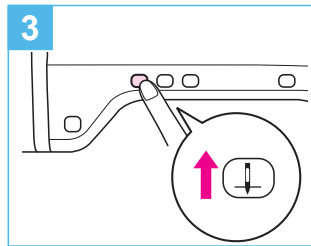
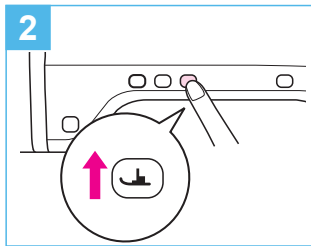
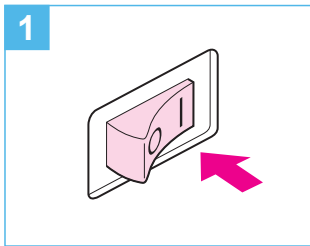
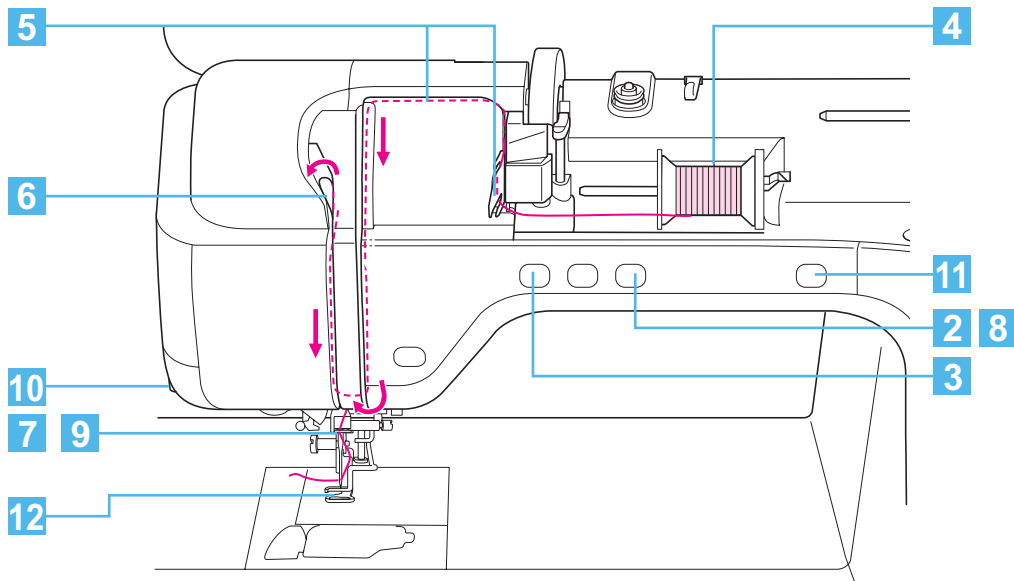

Preparing to Embroider
Préparation de la broderie
Preparativi per il ricamo
Preparando para bordar

Vorbereitung zum Sticken
Vorbereidingen voor borduren
Preparativos para bordar
Подготовка к вышиванию

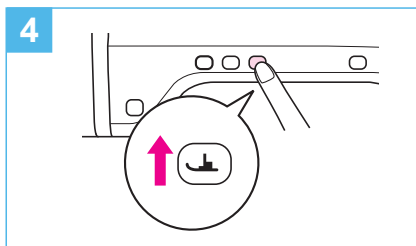
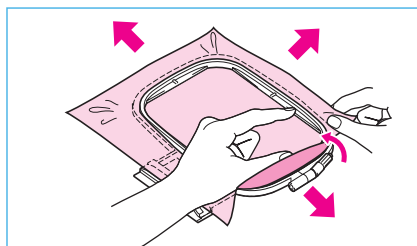
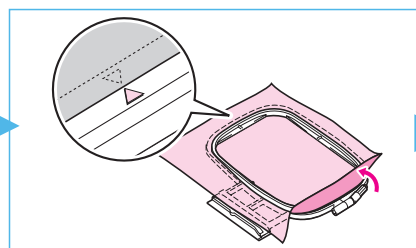
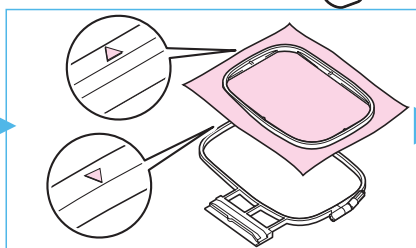
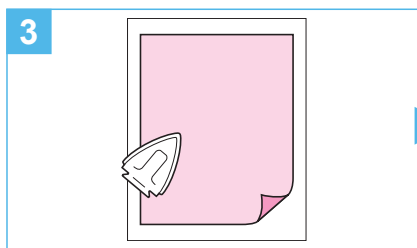
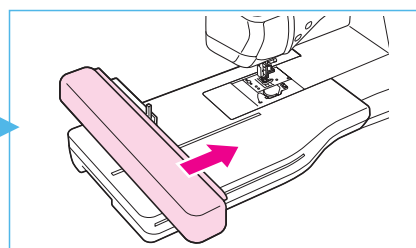
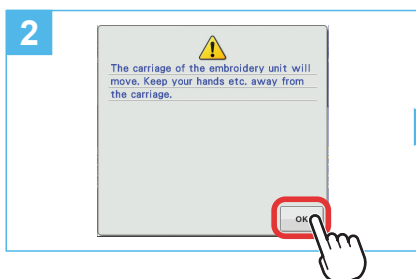
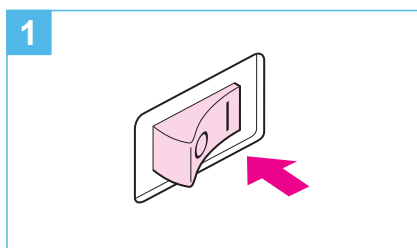
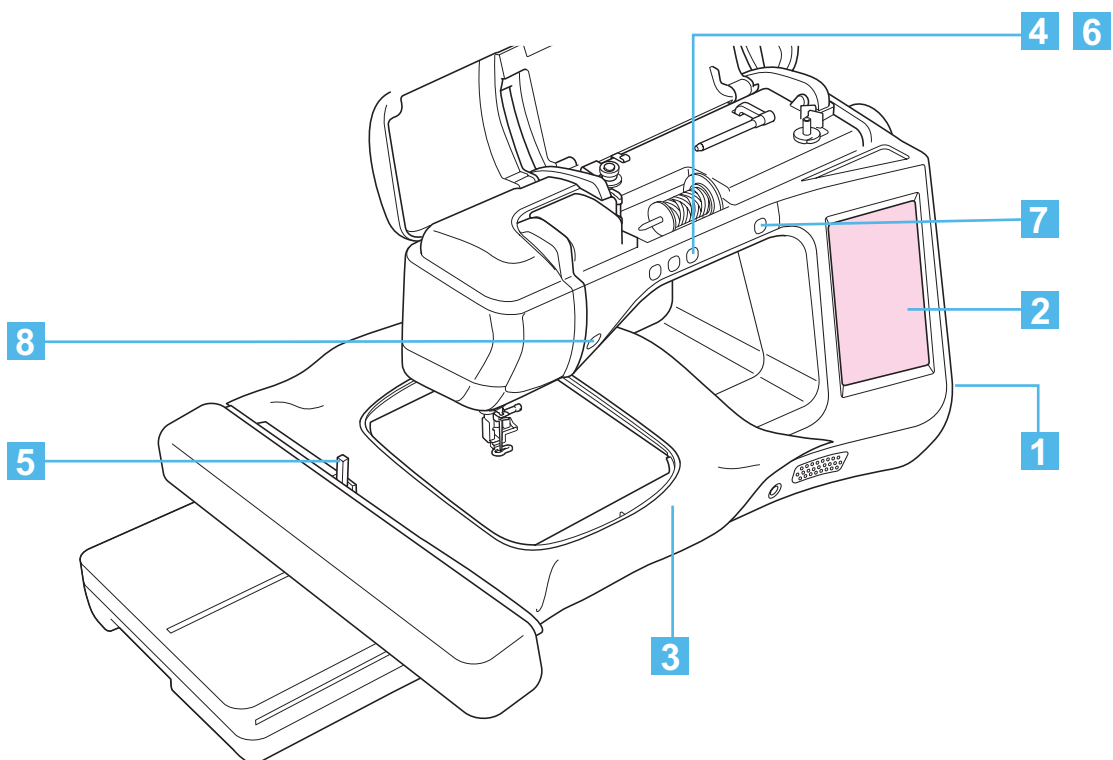

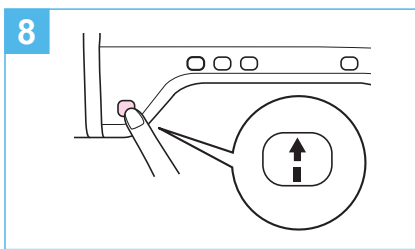
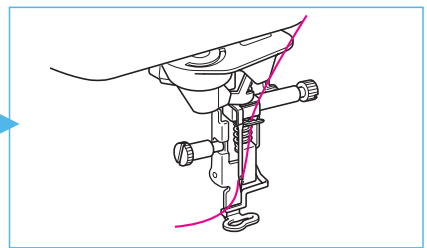
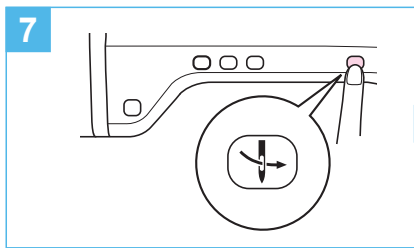
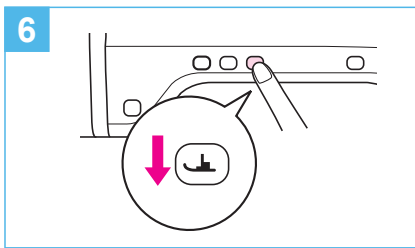
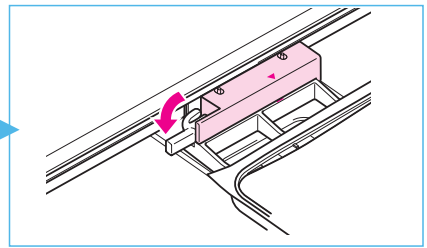
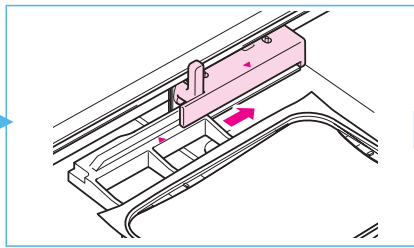
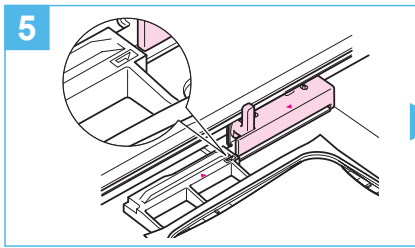

Selecting Stitch Patterns

Sélection des configurations de point
Selezione degli schemi punto
Selecionando padrões de pontos

Wahl des Stickmusters

Kiezen van de steekpatronen
Selección de tipos de puntada
Выбор рисунков для вышивания

- ◆ LCD Flow Chart
- ◆ Organigramme de l'écran à cristaux liquides
- ◆ Schema di flusso LCD
- ◆ Fluxograma do display LCD

- ◆ LCD-Übersichtsdiagramm
- ◆ LCD-stroomschema
- ◆ Diagrama de flujo del LCD
- ◆ Схема действий на LCD дисплее

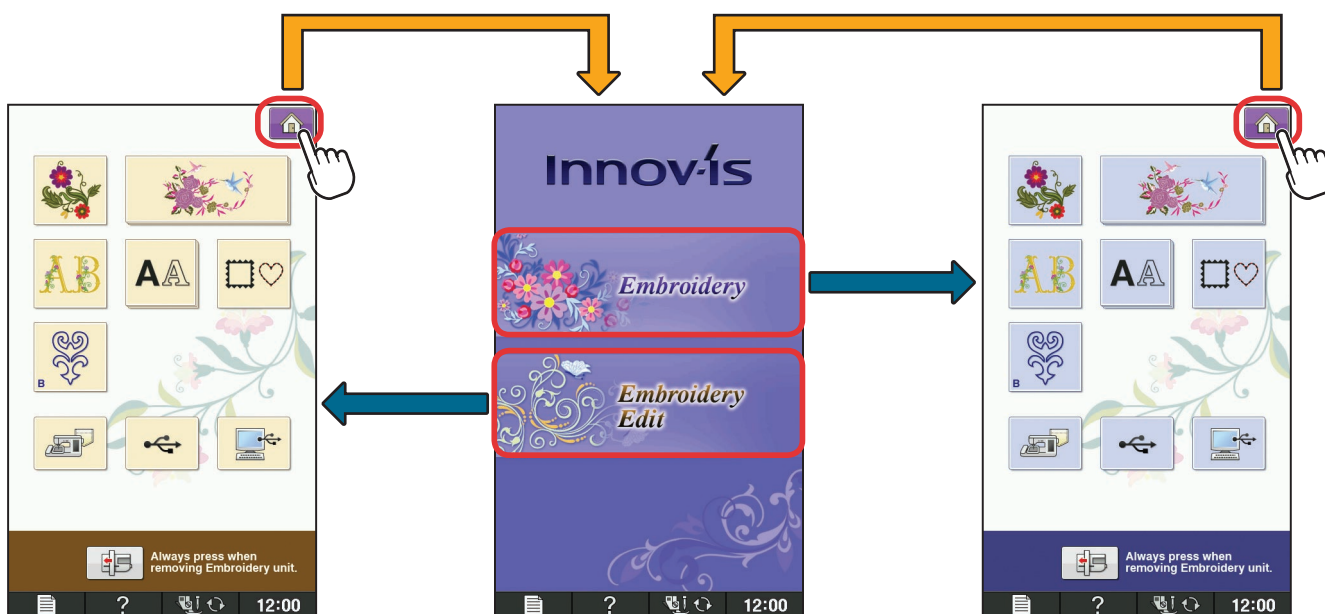

◆ Embroidery Patterns

When the machine is turned on, the opening movie is played. Touch the screen to display the home screen. Press  to display the Embroidery Screen.

◆ Motifs de broderie

Quand la machine est mise sous tension, la vidéo de démarrage commence. Touchez l'écran pour afficher la page d'accueil. Appuyez sur  pour afficher l'écran Broderie.

◆ Schemi di ricamo

All'accensione della macchina, viene riprodotto il filmato di apertura. Toccare lo schermo per visualizzare la schermata iniziale. Premere  per visualizzare la schermata di ricamo.

◆ Padrões de bordado

Quando a máquina estiver ligada, o vídeo de abertura será reproduzido. Toque na tela para exibir a tela inicial. Pressione  para exibir a Tela de Bordado.

◆ Stickmuster

Nach dem Einschalten der Maschine wird der Eingangsfilm angezeigt. Berühren Sie den Bildschirm zur Anzeige des Startbildschirms. Drücken Sie  zur Anzeige des Stickbildschirms.



◆ Borduurpatronen

Wanneer u de machine aanzet, wordt de openingsfilm afgespeeld. Raak het scherm aan om het beginscherm weer te geven. Druk op  om het borduurscherm weer te geven.

◆ Patrones de bordado

Cuando se activa la máquina, se reproduce el vídeo de presentación. Toque la pantalla para visualizar la pantalla inicial. Pulse  para visualizar la pantalla de bordado.

◆ Рисунки для вышивания

После включения машины воспроизводится вступительный видеоролик. Прикоснитесь к экрану, чтобы отобразить начальный экран. Нажмите  , чтобы открыть экран вышивания.

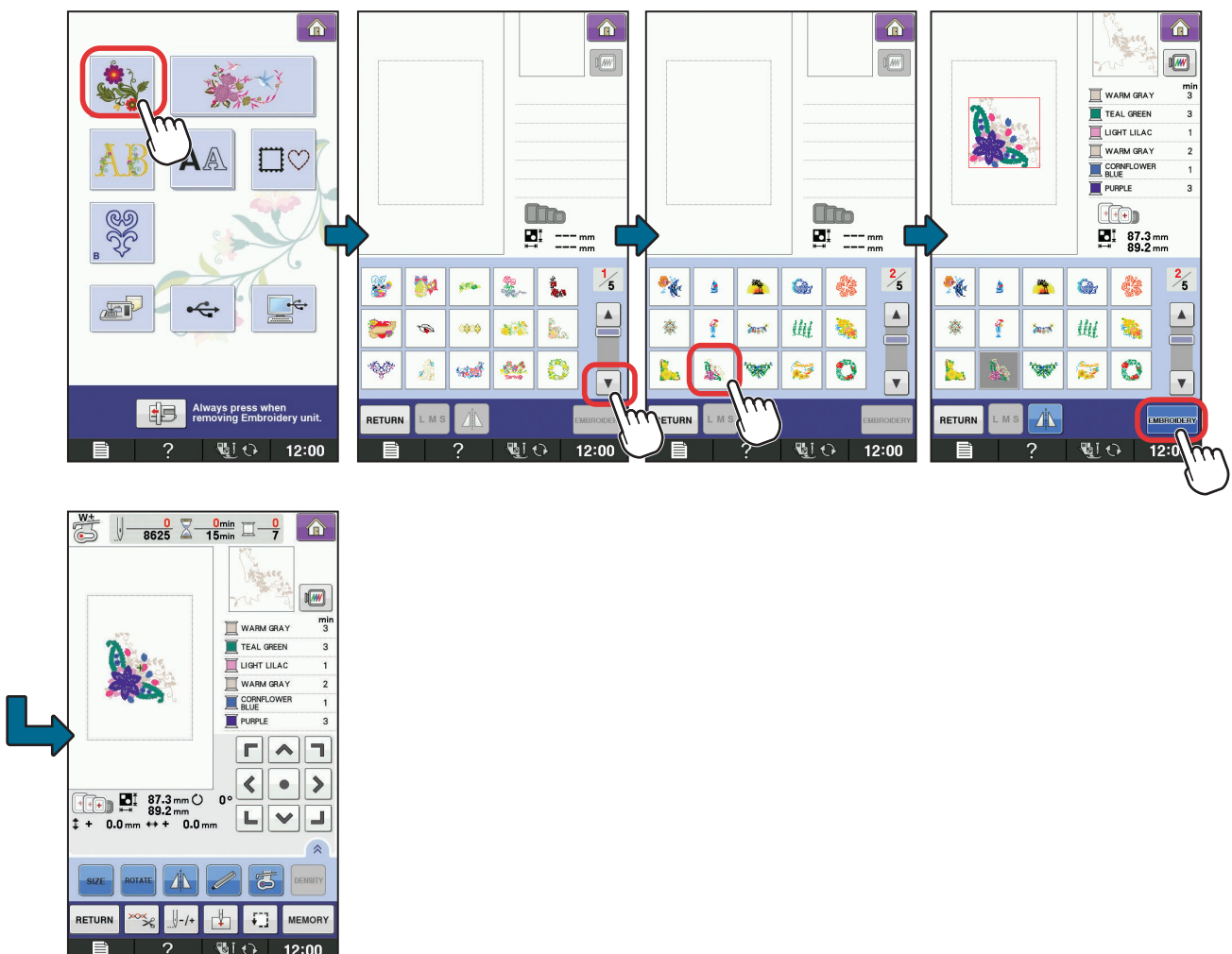

◆ Embroidery Edit Patterns

◆ Motifs de modification de broderie

◆ Schemi di modifica ricamo

◆ Padrões de edição de bordado

◆ Editieren von Stickmustern

◆ Borduurbewerkingspatronen

◆ Patrones de edición de bordado

◆ Редактирование рисунков для вышивания

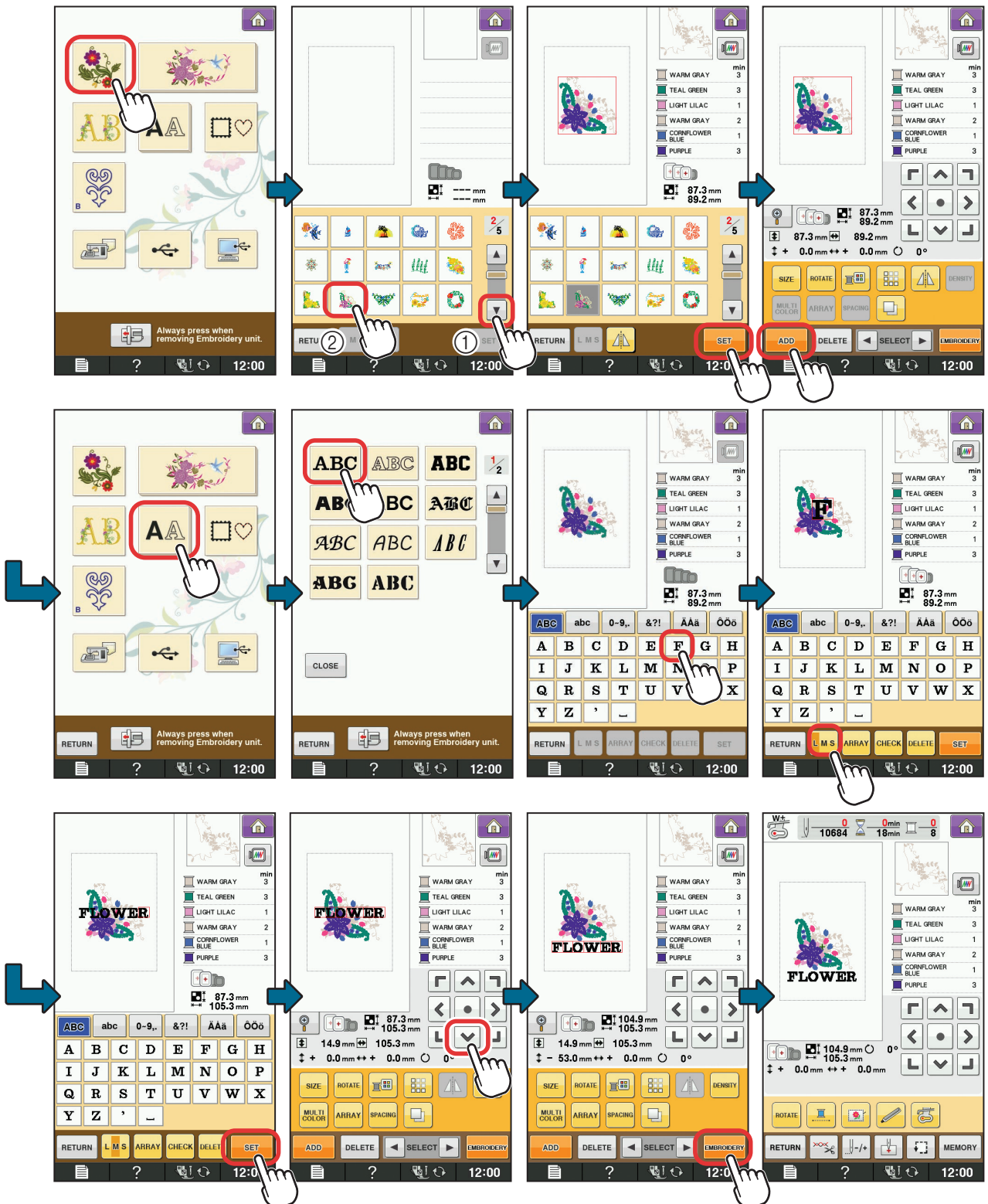

◆ Settings

◆ Réglages

◆ Impostazioni

◆ Configurações

◆ Einstellungen

◆ Instellingen

◆ Ajustes

◆ Настройки

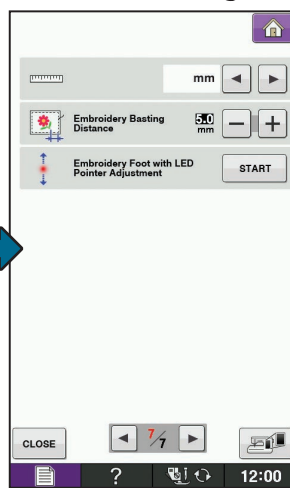
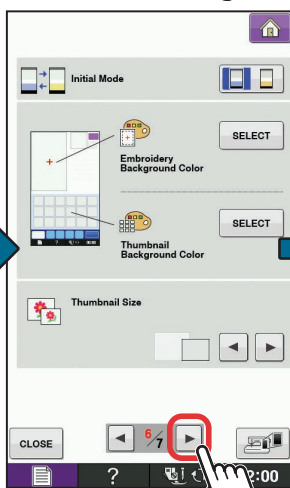
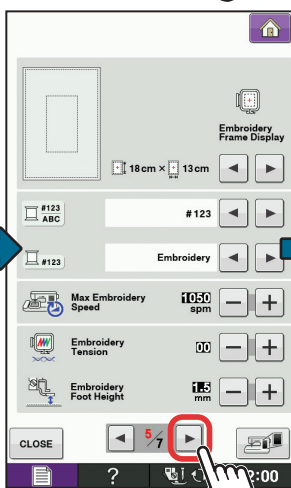
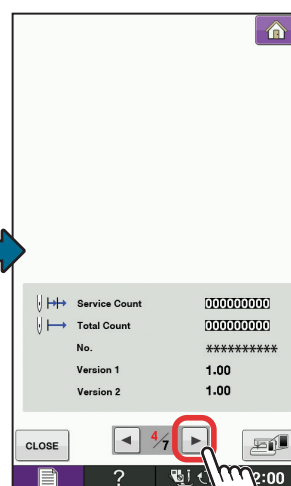
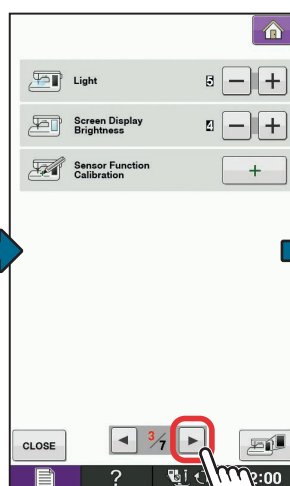
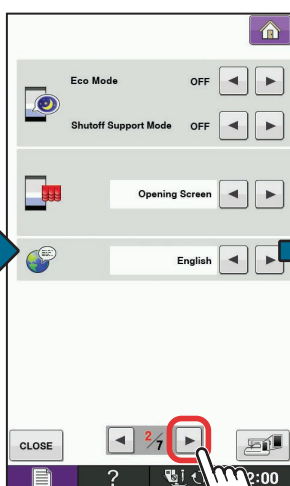
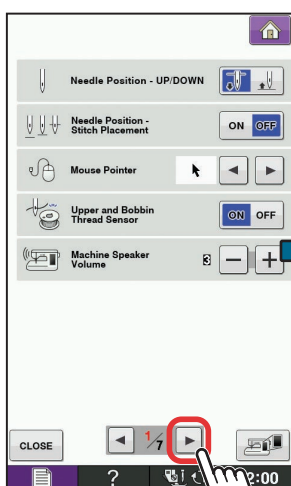

Summary of Stitch Patterns
 Sommaire des motifs de point
 Sommario degli schemi punto
 Resumo de padrões de pontos

Stickmuster-Übersicht
 Overzicht van de steekpatronen
 Resumen de tipos de puntada
 Образцы рисунков для вышивания

◆ Embroidery Patterns

◆ Motifs de broderie

◆ Schemi di ricamo

◆ Padrões de bordado

◆ Stickmuster

◆ Borduurpatronen

◆ Patrones de bordado

◆ Рисунки для вышивания

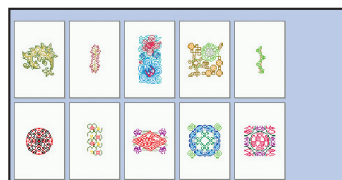
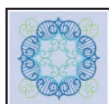
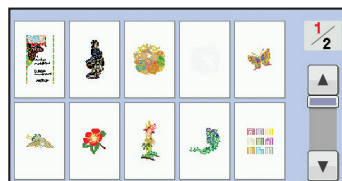
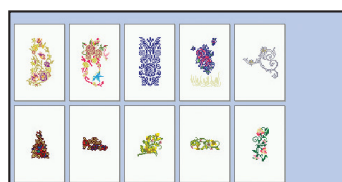
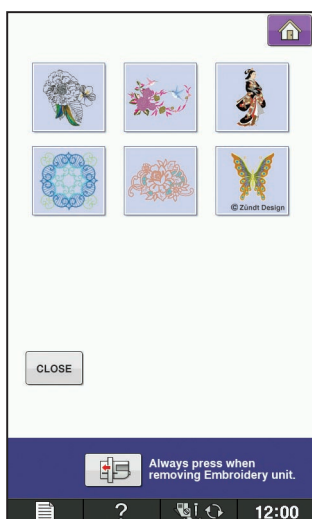
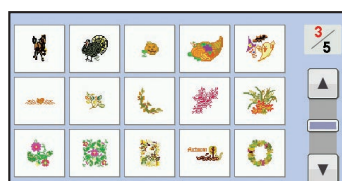
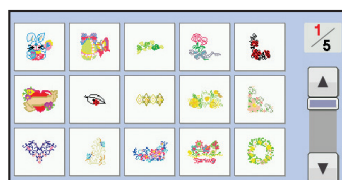

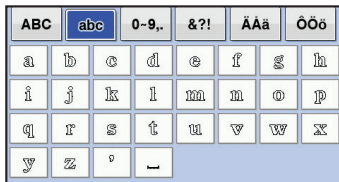
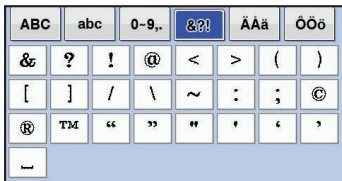
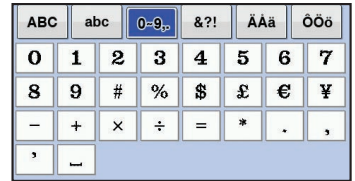
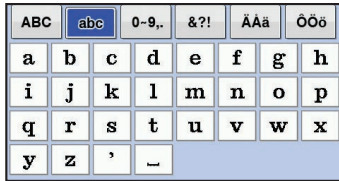
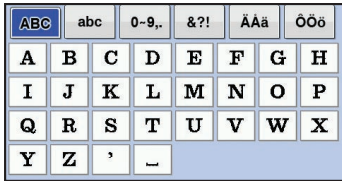
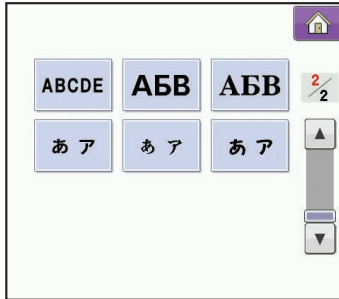
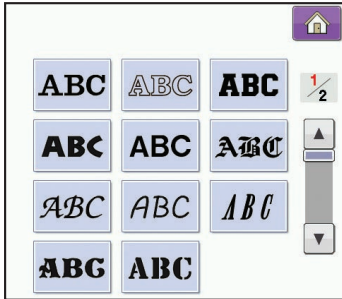
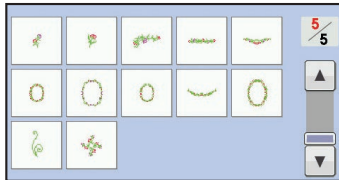
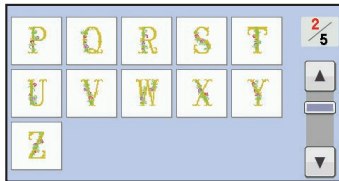
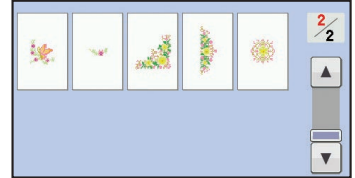
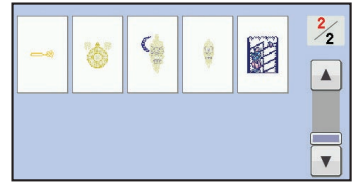
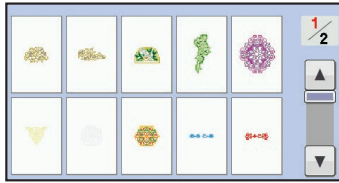

ABC	abc	0-9..	&?!	ÄÄä	ÖÖö		
&	?	!	@	<	>	()
[]	/	\	~	:	:	©
®	™	“	”	”	’	’	’
_							

ABC	abc	0-9..	&?!	ÄÄä	ÖÖö		
Ä	Ä	Ä	ä	ä	ä	ä	ä
å	Æ	æ	Ç	ç	È	É	Ê
Ë	è	é	ê	ë	Ï	ì	ï
Ð	Ñ	ñ	’	_			

ABC	abc	0-9..	&?!	ÄÄä	ÖÖö		
Ô	Ö	Ø	ò	ó	ô	õ	ø
Û	Ü	ù	ú	û	ü	Þ	þ
ß	ı	İ	Ñ	Ó	ó	œ	œ
ř	ť	ž	’	_			

ABC

ABC	abc	0-9..	&?!	ÄÄä	ÖÖö		
A	B	C	D	E	F	G	H
I	J	K	L	M	N	O	P
Q	R	S	T	U	V	W	X
Y	Z	’	_				

ABC	abc	0-9..	&?!	ÄÄä	ÖÖö		
a	b	c	d	e	f	g	h
i	j	k	l	m	n	o	p
q	r	s	t	u	v	w	x
y	z	’	_				

ABC	abc	0-9..	&?!	ÄÄä	ÖÖö		
0	1	2	3	4	5	6	7
8	9	#	%	\$	£	€	¥
-	+	x	÷	=	*	.	.
’	_						

ABC	abc	0-9..	&?!	ÄÄä	ÖÖö		
&	?	!	@	<	>	()
[]	/	\	~	:	:	©
®	™	“	”	”	’	’	’
_							

ABC	abc	0-9..	&?!	ÄÄä	ÖÖö		
Ä	Ä	Ä	ä	ä	ä	ä	ä
å	Æ	æ	Ç	ç	È	É	Ê
Ë	è	é	ê	ë	Ï	ì	ï
Ð	Ñ	ñ	’	_			

ABC	abc	0-9..	&?!	ÄÄä	ÖÖö		
Ô	Ö	Ø	ò	ó	ô	õ	ø
Û	Ü	ù	ú	û	ü	Þ	þ
ß	ı	İ	Ñ	Ó	ó	œ	œ
ř	ť	ž	’	_			

ABC

ABC	abc	0-9..	&?!	ÄÄä	ÖÖö		
A	B	C	D	E	F	G	H
I	J	K	L	M	N	O	P
Q	R	S	T	U	V	W	X
Y	Z	’	_				

ABC	abc	0-9..	&?!	ÄÄä	ÖÖö		
a	b	c	d	e	f	g	h
i	j	k	l	m	n	o	p
q	r	s	t	u	v	w	x
y	z	’	_				

ABC	abc	0-9..	&?!	ÄÄä	ÖÖö		
0	1	2	3	4	5	6	7
8	9	#	%	\$	£	€	¥
-	+	x	÷	=	*	.	,
’	_						

ABC	abc	0-9..	&?!	ÄÄä	ÖÖö		
&	?	!	@	<	>	()
[]	/	\	~	:	:	©
®	™	“	”	”	’	’	’
_							

ABC	abc	0-9..	&?!	ÄÄä	ÖÖö		
Ä	Ä	Ä	ä	ä	ä	ä	ä
å	Æ	æ	Ç	ç	È	É	Ê
Ë	è	é	ê	ë	Ï	ì	ï
Ð	Ñ	ñ	’	_			

ABC	abc	0-9..	&?!	ÄÄä	ÖÖö		
Ô	Ö	Ø	ò	ó	ô	õ	ø
Û	Ü	ù	ú	û	ü	Þ	þ
ß	ı	İ	Ñ	Ó	ó	œ	œ
ř	ť	ž	’	_			

ABC

ABC	abc	0-9..	&?!	ÄÄä	ÖÖö		
A	B	C	D	E	F	G	H
I	J	K	L	M	N	O	P
Q	R	S	T	U	V	W	X
Y	Z	’	_				

ABC	abc	0-9..	&?!	ÄÄä	ÖÖö		
a	b	c	d	e	f	g	h
i	j	k	l	m	n	o	p
q	r	s	t	u	v	w	x
y	z	’	_				

ABC	abc	0-9..	&?!	ÄÄä	ÖÖö		
0	1	2	3	4	5	6	7
8	9	#	%	\$	£	€	¥
-	+	x	÷	=	*	.	,
’	_						

ABC	abc	0-9..	&?!	ÄÄä	ÖÖö		
&	?	!	@	<	>	()
[]	/	\	~	:	:	©
®	™	“	”	”	’	’	’
_							

ABC	abc	0-9..	&?!	ÄÄä	ÖÖö		
Ä	Ä	Ä	ä	ä	ä	ä	ä
å	Æ	æ	Ç	ç	È	É	Ê
Ë	è	é	ê	ë	Ï	ì	ï
Ð	Ñ	ñ	’	_			

ABC	abc	0-9..	&?!	ÄÄä	ÖÖö		
Ô	Ö	Ø	ò	ó	ô	õ	ø
Û	Ü	ù	ú	û	ü	Þ	þ
ß	ı	İ	Ñ	Ó	ó	œ	œ
ř	ť	ž	’	_			

ABC

ABC	abc	0-9..	&?!				
À	Á	Â	Ã	Ä	Å	Æ	Ç
È	É	Ê	Ë	Ì	Í	Î	Ï
Ð	Ñ	Ò	Ó	Ô	Õ	Ö	×
Ø	Ù	Ú	Û	Ü	Ý	Þ	ß
à	á	â	ã	ä	å	æ	ç
è	é	ê	ë	ì	í	î	ï
ð	ñ	ò	ó	ô	õ	ö	×
ø	ù	ú	û	ü	ý	þ	ÿ
’	_						

ABC	abc	0-9..	&?!				
a	b	c	d	e	f	g	h
i	j	k	l	m	n	o	p
q	r	s	t	u	v	w	x
y	z	’	_				

ABC	abc	0-9..	&?!				
0	1	2	3	4	5	6	7
8	9	-	=	.	,	’	_

ABC	abc	0-9..	&?!				
&	?	!	<	>	[]	/
\	~	:	:	”	”	’	’
_							

ABC

ABC	abc	0-9..	&?!	ÄÄä	ÖÖö		
A	B	C	D	E	F	G	H
I	J	K	L	M	N	O	P
Q	R	S	T	U	V	W	X
Y	Z	'	_				

ABC	abc	0-9..	&?!	ÄÄä	ÖÖö		
a	b	c	d	e	f	g	h
i	j	k	l	m	n	o	p
q	r	s	t	u	v	w	x
y	z	'	_				

ABC	abc	0-9..	&?!	ÄÄä	ÖÖö		
0	1	2	3	4	5	6	7
8	9	#	%	\$	£	€	¥
-	+	x	÷	=	*	.	,
'	_						

ABC	abc	0-9..	&?!	ÄÄä	ÖÖö		
&	?	!	@	<	>	()
[]	/	\	~	:	;	©
®	™	"	"	"	'	'	'
_							

ABC	abc	0-9..	&?!	ÄÄä	ÖÖö		
Ä	Ä	Ä	ä	á	â	ã	ä
å	Æ	æ	Ç	ç	È	É	Ê
Ë	è	é	ê	ë	Ï	ì	í
Ð	Ñ	ñ	'	_			

ABC	abc	0-9..	&?!	ÄÄä	ÖÖö		
Ô	Õ	Ø	ò	ó	ô	õ	ø
Ù	Ú	ù	ú	û	ü	Ɔ	Ɔ
ß	ı	İ	Ñ	Ö	ö	Œ	œ
ƒ	ŧ	ž	'	_			

ABC

ABC	abc	0-9..	&?!	ÄÄä	ÖÖö		
A	B	C	D	E	F	G	H
I	J	K	L	M	N	O	P
Q	R	S	T	U	V	W	X
Y	Z	'	_				

ABC	abc	0-9..	&?!	ÄÄä	ÖÖö		
a	b	c	d	e	f	g	h
i	j	k	l	m	n	o	p
q	r	s	t	u	v	w	x
y	z	'	_				

ABC	abc	0-9..	&?!	ÄÄä	ÖÖö		
0	1	2	3	4	5	6	7
8	9	#	%	\$	£	€	¥
-	+	x	÷	=	*	.	,
'	_						

ABC	abc	0-9..	&?!	ÄÄä	ÖÖö		
&	?	!	@	<	>	()
[]	/	\	~	:	;	©
®	™	"	"	"	'	'	'
_							

ABC	abc	0-9..	&?!	ÄÄä	ÖÖö		
Â	Ã	Ä	à	á	â	ã	ä
å	Æ	æ	Ç	ç	È	É	Ê
Ë	è	é	ê	ë	Ï	ì	í
Ð	Ñ	ñ	'	_			

ABC	abc	0-9..	&?!	ÄÄä	ÖÖö		
Ô	Õ	Ø	ò	ó	ô	õ	ø
Ù	Ú	ù	ú	û	ü	Ɔ	Ɔ
ß	ı	İ	Ñ	Ö	ö	Œ	œ
ƒ	ŧ	ž	'	_			

ABC

ABC	abc	0-9..	&?!	ÄÄä	ÖÖö		
A	B	C	D	E	F	G	H
I	J	K	L	M	N	O	P
Q	R	S	T	U	V	W	X
Y	Z	'	_				

ABC	abc	0-9..	&?!	ÄÄä	ÖÖö		
a	b	c	d	e	f	g	h
i	j	k	l	m	n	o	p
q	r	s	t	u	v	w	x
y	z	'	_				

ABC	abc	0-9..	&?!	ÄÄä	ÖÖö		
0	1	2	3	4	5	6	7
8	9	#	%	\$	£	€	¥
-	+	x	÷	=	*	.	,
'	_						

ABC	abc	0-9..	&?!	ÄÄä	ÖÖö		
&	?	!	@	<	>	()
[]	/	\	~	:	;	©
®	™	"	"	"	'	'	'
_							

ABC	abc	0-9..	&?!	ÄÄä	ÖÖö		
Á	Â	Ã	à	á	â	ã	ä
å	Æ	æ	Ç	ç	È	É	Ê
Ë	è	é	ê	ë	Ï	ì	í
Ð	Ñ	ñ	'	_			

ABC	abc	0-9..	&?!	ÄÄä	ÖÖö		
Ô	Õ	Ø	ò	ó	ô	õ	ø
Ù	Ú	ù	ú	û	ü	Ɔ	Ɔ
ß	ı	İ	Ñ	Ö	ö	Œ	œ
ƒ	ŧ	ž	'	_			

ABC

ABC	abc	0-9..	&?!	ÄÄä	ÖÖö		
A	B	C	D	E	F	G	H
I	J	K	L	M	N	O	P
Q	R	S	T	U	V	W	X
Y	Z	'	_				

ABC	abc	0-9..	&?!	ÄÄä	ÖÖö		
a	b	c	d	e	f	g	h
i	j	k	l	m	n	o	p
q	r	s	t	u	v	w	x
y	z	'	_				

ABC	abc	0-9..	&?!	ÄÄä	ÖÖö		
0	1	2	3	4	5	6	7
8	9	#	%	\$	£	€	¥
-	+	x	÷	=	*	.	,
'	_						

ABC	abc	0-9..	&?!	ÄÄä	ÖÖö		
&	?	!	@	<	>	()
[]	/	\	~	:	;	©
®	™	"	"	"	'	'	'
_							

ABC	abc	0-9..	&?!	ÄÄä	ÖÖö		
À	Á	Â	à	á	â	ã	ä
å	Æ	æ	Ç	ç	È	É	Ê
Ë	è	é	ê	ë	Ï	ì	í
Ð	Ñ	ñ	'	_			

ABC	abc	0-9..	&?!	ÄÄä	ÖÖö		
Ô	Õ	Ø	ò	ó	ô	õ	ø
Ù	Ú	ù	ú	û	ü	Ɔ	Ɔ
ß	ı	İ	Ñ	Ö	ö	Œ	œ
ƒ	ŧ	ž	'	_			

ABC

ABC	abc	0-9..	&?!	ÄÄä	ÖÖö		
A	B	C	D	E	F	G	H
I	J	K	L	M	N	O	P
Q	R	S	T	U	V	W	X
Y	Z	'	_				

ABC	abc	0-9..	&?!	ÄÄä	ÖÖö		
a	b	c	d	e	f	g	h
i	j	k	l	m	n	o	p
q	r	s	t	u	v	w	x
y	z	'	_				

ABC	abc	0-9..	&?!	ÄÄä	ÖÖö		
0	1	2	3	4	5	6	7
8	9	#	%	\$	£	€	¥
-	+	x	÷	=	*	.	,
'	_						

ABC	abc	0-9..	&?! 	ÃÄä	ÕÖö		
&	?	!	@	<	>	()
[]	/	\	~	:	;	©
®	™	“	”	”	’	‘	’
—							

ABC	abc	0-9..	&?! 	ÃÄä	ÕÖö		
Â	Ã	Ä	à	á	â	ã	ä
å	Æ	æ	Ç	ç	È	É	Ê
Ë	è	é	ê	ë	Ï	ì	í
Ð	Ñ	ñ	’	—			

ABC	abc	0-9..	&?! 	ÃÄä	ÕÖö		
Ó	Ô	Õ	ò	ó	ô	õ	ø
Ù	Û	ù	ú	û	ü	Þ	þ
ß	ı	İ	Ñ	Ó	õ	œ	œ
ř	ť	ž	’	—			

ABCDE

ABC	abc	0-9..	&?! 	ÃÄä	ÕÖö		
A	B	C	D	E	F	G	H
I	J	K	L	M	N	O	P
Q	R	S	T	U	V	W	X
Y	Z	’	—				

ABC	abc	0-9..	&?! 	ÃÄä	ÕÖö		
a	b	c	d	e	f	g	h
i	j	k	l	m	n	o	p
q	r	s	t	u	v	w	x
y	z	’	—				

ABC	abc	0-9..	&?! 	ÃÄä	ÕÖö		
0	1	2	3	4	5	6	7
8	9	#	%	\$	£	€	¥
-	+	x	÷	=	*	.	,
’	—						

ABC	abc	0-9..	&?! 	ÃÄä	ÕÖö		
&	?	!	@	<	>	()
[]	/	\	~	:	;	©
®	™	“	”	”	’	‘	’
—							

ABC	abc	0-9..	&?! 	ÃÄä	ÕÖö		
Â	Ã	Ä	à	á	â	ã	ä
å	Æ	æ	Ç	ç	È	É	Ê
Ë	è	é	ê	ë	Ï	ì	í
Ð	Ñ	ñ	’	—			

ABC	abc	0-9..	&?! 	ÃÄä	ÕÖö		
Ó	Ô	Õ	ò	ó	ô	õ	ø
Ù	Û	ù	ú	û	ü	Þ	þ
ß	ı	İ	Ñ	Ó	õ	œ	œ
ř	ť	ž	’	—			

АБВ

АБВ	ЧШЦ	абв	чшц	0-9..			
А	Б	В	Г	Д	Е	Ё	Ж
З	И	Й	К	Л	М	Н	О
П	Р	С	Т	У	Ф	Х	Ц
—							

АБВ	ЧШЦ	абв	чшц	0-9..			
Ч	Ш	Щ	Ъ	Ы	Ь	Э	Ю
Я	Г	Є	І	Ї	Ў	Ғ	Ң
Ј	Љ	Њ	Џ	Ѓ	Ѕ	Ї	—

АБВ	ЧШЦ	абв	чшц	0-9..			
а	б	в	г	д	е	ё	ж
з	и	й	к	л	м	н	о
п	р	с	т	у	ф	х	ц
—							

АБВ	ЧШЦ	абв	чшц	0-9..			
ч	ш	щ	ъ	ы	ь	э	ю
я	г	є	і	ї	ў	ғ	ң
ј	љ	њ	џ	ѓ	ѕ	ѝ	—

АБВ	ЧШЦ	абв	чшц	0-9..			
0	1	2	3	4	5	6	7
8	9	-	.	,	&	?	!
()	/	’	—			

АБВ

АБВ	ЧШЦ	абв	чшц	0-9..			
А	Б	В	Г	Д	Е	Ё	Ж
З	И	Й	К	Л	М	Н	О
П	Р	С	Т	У	Ф	Х	Ц
—							

АБВ	ЧШЦ	абв	чшц	0-9..			
Ч	Ш	Щ	Ъ	Ы	Ь	Э	Ю
Я	Г	Є	І	Ї	Ў	Ғ	Ң
Ј	Љ	Њ	Џ	Ѓ	Ѕ	Ї	—

АБВ	ЧШЦ	абв	чшц	0-9..			
а	б	в	г	д	е	ё	ж
з	и	й	к	л	м	н	о
п	р	с	т	у	ф	х	ц
—							

АБВ	ЧШЦ	абв	чшц	0-9..			
ч	ш	щ	ъ	ы	ь	э	ю
я	г	є	і	ї	ў	ғ	ң
ј	љ	њ	џ	ѓ	ѕ	ѝ	—

АБВ	ЧШЦ	абв	чшц	0-9..			
0	1	2	3	4	5	6	7
8	9	-	.	,	&	?	!
()	/	’	—			



* Katakana characters: One of the character sets of Japanese.
 Katakana-Zeichen: Einer der Zeichensätze für Japanisch.
 Caractères Katakana : l'un des jeux de caractères japonais.
 Catalaan-tekens: een van de tekensets van Japans.
 Caratteri Katakana: uno dei set di caratteri della lingua giapponese.
 Caracteres Katakana: uno de los grupos de caracteres del japonés.
 Caracteres katakana: um dos sistemas de caracteres do alfabeto japonés.
 Катакана: один из наборов символов (азбука) в японском языке.

Hiragana characters: One of the character sets of Japanese.
 Hiragana-Zeichen: Einer der Zeichensätze für Japanisch.
 Caractères Hiragana : l'un des jeux de caractères japonais.
 Hiragana-tekens: een van de tekensets van Japans.
 Caratteri Hiragana: uno dei set di caratteri della lingua giapponese.
 Caracteres Hiragana: uno de los grupos de caracteres del japonés.
 Caracteres hiragana: um dos sistemas de caracteres do alfabeto japonés.
 Хирагана: один из наборов символов (азбука) в японском языке.

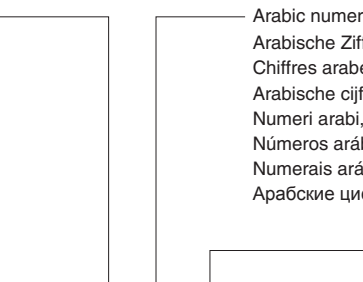

Horizontal
 Horizontal
 Horizontal
 Horizontal
 Horizontal
 Horizontal
 По горизонтали

Vertical
 Vertikal
 Vertical
 Vertical
 Vertical
 Vertical
 По вертикали

Arabic numerals, Japanese Kanji numerals
 Arabische Ziffern, japanische Kanji-Ziffern
 Chiffres arabes, chiffres Kanji japonais
 Arabische cijfers, Japanse Kanji-cijfers
 Numeri arabi, numeri Kanji giapponesi
 Números arábigos, números Kanji japoneses
 Numerais arábicos, numerais japoneses em kanji
 Арабские цифры и иероглифы кандзи

Kanji characters often used in daily life / symbols.
 Im Alltag häufig verwendete Kanji-Zeichen / Symbole.
 Les caractères Kanji sont souvent utilisés dans la vie de tous les jours / symboles.
 Kanji-tekens worden vaak gebruikt in het dagelijks leven / symbolen.
 Caratteri Kanji spesso utilizzati nella vita quotidiana / simboli.
 Los caracteres Kanji se utilizan a menudo en la vida diaria / como símbolos.
 Caracteres kanji utilizados frecuentemente no cotidiano / símbolos.
 Иероглифы кандзи часто используются в повседневной жизни или как символы.



* Japanese characters
 * Caratteri giapponesi

* Japanische Zeichen
 * Caracteres japoneses

* Caractères japonais
 * Caracteres do alfabeto japonés

* Japanse tekens
 * Японские иероглифы

あいう	アイウ	0-9 &?!	年組	H	V
ア	カ	サ	タ	ナ	ハ
マ	ヤ	ラ	ワ		
ハ	ヒ	フ	ヘ	ホ	
バ	ビ	ブ	ベ	ボ	
パ	ピ	プ	ペ	ポ	ー

あいう	アイウ	0-9 &?!	年組	H	V
ア	カ	サ	タ	ナ	ハ
マ	ヤ	ラ	ワ		
マ	ミ	ム	メ	モ	
					ー

あいう	アイウ	0-9 &?!	年組	H	V
ア	カ	サ	タ	ナ	ハ
マ	ヤ	ラ	ワ		
ヤ	ユ	ヨ			
ヤ	ユ	ヨ			ー

あいう	アイウ	0-9 &?!	年組	H	V
ア	カ	サ	タ	ナ	ハ
マ	ヤ	ラ	ワ		
ラ	リ	ル	レ	ロ	
					ー

あいう	アイウ	0-9 &?!	年組	H	V
ア	カ	サ	タ	ナ	ハ
マ	ヤ	ラ	ワ		
ワ	ヲ	ン			
					ー

あいう	アイウ	0-9 &?!	年組	H	V
0	1	2	3	4	5
6	7	8	9	0	ー
二	三	四	五		
六	七	八	九	十	
&	?	!	()	ー

あいう	アイウ	0-9 &?!	年組	H	V
生	年	月	日	才	小
中	学	校	組	火	水
木	金	土	保		
育	幼	稚	園	番	部
班	会	係	名	前	ー

あア *

あいう	アイウ	0-9 &?!	年組	H	V
あ	い	う	え	お	
あ	い	う	え	お	
					ー

あいう	アイウ	0-9 &?!	年組	H	V
あ	い	う	え	お	
か	き	く	け	こ	
が	ぎ	ぐ	げ	ご	
					ー

あいう	アイウ	0-9 &?!	年組	H	V
あ	い	う	え	お	
さ	し	す	せ	そ	
ざ	じ	ず	ぜ	ぞ	
					ー

あいう	アイウ	0-9 &?!	年組	H	V
あ	い	う	え	お	
た	ち	つ	て	と	
だ	ぢ	づ	で	ど	
		っ			ー

あいう	アイウ	0-9 &?!	年組	H	V
あ	い	う	え	お	
な	に	ぬ	ね	の	
					ー

あいう	アイウ	0-9 &?!	年組	H	V
あ	い	う	え	お	
は	ひ	ふ	へ	ほ	
ば	び	ぶ	べ	ぼ	
ぱ	ぴ	ぷ	ぺ	ぽ	ー

あいう	アイウ	0-9 &?!	年組	H	V
あ	い	う	え	お	
ま	み	む	め	も	
					ー

あいう	アイウ	0-9 &?!	年組	H	V
あ	い	う	え	お	
や	ゆ	よ			
や	ゆ	よ			ー

あいう	アイウ	0-9 &?!	年組	H	V
あ	い	う	え	お	
ら	り	る	れ	る	
					ー

あいう	アイウ	0-9 &?!	年組	H	V
あ	い	う	え	お	
わ	を	ん			
					ー

あいう	アイウ	0-9 &?!	年組	H	V
ア	イ	ウ	エ	オ	
ア	イ	ウ	エ	オ	
					ー

あいう	アイウ	0-9 &?!	年組	H	V
ア	カ	キ	ク	ケ	コ
ガ	ギ	グ	ゲ	ゴ	
					ー

あいう	アイウ	0-9 &?!	年組	H	V
ア	カ	サ	タ	ナ	ハ
マ	ヤ	ラ	ワ		
サ	シ	ス	セ	ソ	
ザ	ジ	ズ	ゼ	ゾ	
					ー

あいう	アイウ	0-9 &?!	年組	H	V
ア	カ	サ	タ	ナ	ハ
マ	ヤ	ラ	ワ		
タ	チ	ツ	テ	ト	
ダ	ヂ	ヅ	デ	ド	
					ー

あいう	アイウ	0-9 &?!	年組	H	V
ア	カ	サ	タ	ナ	ハ
マ	ヤ	ラ	ワ		
ナ	ニ	ヌ	ネ	ノ	
					ー

Summary of Stitch Patterns
 Stickmuster-Übersicht
 Sommaire des motifs de point
 Overzicht van de steekpatronen
 Sommario degli schemi punto
 Resumen de tipos de puntada
 Resumo de padrões de pontos
 Образцы рисунков для вышивания

あいう	アイウ	0-9 &?!	年組	H V					
ア	カ	サ	タ	ナ	ハ	マ	ヤ	ラ	ワ
ハ	ヒ	フ	ヘ	ホ					
バ	ビ	ブ	ベ	ボ					
バ	ビ	ブ	ベ	ボ					

あいう	アイウ	0-9 &?!	年組	H V					
ア	カ	サ	タ	ナ	ハ	マ	ヤ	ラ	ワ
マ	ミ	ム	メ	モ					

あいう	アイウ	0-9 &?!	年組	H V					
ア	カ	サ	タ	ナ	ハ	マ	ヤ	ラ	ワ
ヤ	ユ	ヨ							
ヤ	ユ	ヨ							

あいう	アイウ	0-9 &?!	年組	H V					
ア	カ	サ	タ	ナ	ハ	マ	ヤ	ラ	ワ
ラ	リ	ル	レ	ロ					

あいう	アイウ	0-9 &?!	年組	H V					
ア	カ	サ	タ	ナ	ハ	マ	ヤ	ラ	ワ
ワ	ヲ	ン							

あいう	アイウ	0-9 &?!	年組	H V					
0	1	2	3	4	5	6	7		
8	9	〇	ー	二	三	四	五		
六	七	八	九	十					
&	?	!	()	ー				

あいう	アイウ	0-9 &?!	年組	H V					
生	年	月	日	才	小	中	学		
校	組	火	水	木	金	土	保		
育	幼	稚	園	番	部	班	会		
係	名	前							

あいう	アイウ	0-9 &?!	年組	H V					
あ	い	う	え	お					
あ	い	う	え	お					

あいう	アイウ	0-9 &?!	年組	H V					
あ	い	う	え	お					
か	き	く	け	こ					
が	ぎ	ぐ	げ	ご					

あいう	アイウ	0-9 &?!	年組	H V					
あ	い	う	え	お					
さ	し	す	せ	そ					
ざ	じ	ず	ぜ	ぞ					

あア *

あいう	アイウ	0-9 &?!	年組	H V					
あ	い	う	え	お					
た	ち	つ	て	と					
だ	ぢ	づ	で	ど					
っ									

あいう	アイウ	0-9 &?!	年組	H V					
あ	い	う	え	お					
な	に	ぬ	ね	の					

あいう	アイウ	0-9 &?!	年組	H V					
あ	い	う	え	お					
は	ひ	ふ	へ	ほ					
ば	び	ぶ	べ	ぼ					
ぱ	ぴ	ぷ	ぺ	ぽ					

あいう	アイウ	0-9 &?!	年組	H V					
あ	い	う	え	お					
ま	み	む	め	も					

あいう	アイウ	0-9 &?!	年組	H V					
あ	い	う	え	お					
や	ゆ	よ							
や	ゆ	よ							

あいう	アイウ	0-9 &?!	年組	H V					
あ	い	う	え	お					
ら	り	る	れ	ろ					

あいう	アイウ	0-9 &?!	年組	H V					
あ	い	う	え	お					
わ	を	ん							

あいう	アイウ	0-9 &?!	年組	H V					
ア	カ	サ	タ	ナ	ハ	マ	ヤ	ラ	ワ
ア	イ	ウ	エ	オ					
ア	イ	ウ	エ	オ					
ヴ									

あいう	アイウ	0-9 &?!	年組	H V					
ア	カ	キ	ク	ケ	コ				
ガ	ギ	グ	ゲ	ゴ					

あいう	アイウ	0-9 &?!	年組	H V					
ア	カ	サ	タ	ナ	ハ	マ	ヤ	ラ	ワ
サ	シ	ス	セ	ソ					
ザ	ジ	ズ	ゼ	ゾ					

あいう	アイウ	0-9 &?!	年組	H V					
ア	カ	サ	タ	ナ	ハ	マ	ヤ	ラ	ワ
タ	チ	ツ	テ	ト					
ダ	ヂ	ヅ	デ	ド					
ッ									

あいう	アイウ	0-9 &?!	年組	H V					
ア	カ	サ	タ	ナ	ハ	マ	ヤ	ラ	ワ
ナ	ニ	ヌ	ネ	ノ					

あいう	アイウ	0-9 &?!	年組	H V					
ア	カ	サ	タ	ナ	ハ	マ	ヤ	ラ	ワ
ハ	ヒ	フ	ヘ	ホ					
バ	ビ	ブ	ベ	ボ					
パ	ピ	プ	ペ	ポ					

あいう	アイウ	0-9 &?!	年組	H V					
ア	カ	サ	タ	ナ	ハ	マ	ヤ	ラ	ワ
マ	ミ	ム	メ	モ					

あいう	アイウ	0-9 &?!	年組	H V					
ア	カ	サ	タ	ナ	ハ	マ	ヤ	ラ	ワ
ヤ	ユ	ヨ							
ヤ	ユ	ヨ							

* Japanese characters
 * Caratteri giapponesi

* Japanische Zeichen
 * Caracteres japoneses

* Caractères japonais
 * Caracteres do alfabeto japonês

* Japanse tekens
 * Японские иероглифы

Summary of Stitch Patterns
 Stickmuster-Übersicht
 Sommaire des motifs de point
 Overzicht van de steekpatronen
 Sommario degli schemi punto
 Resumen de tipos de puntada
 Resumo de padrões de pontos
 Образцы рисунков для вышивания

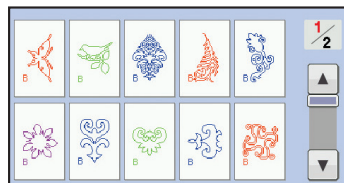
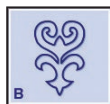
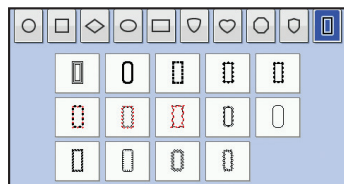
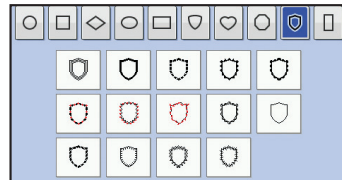
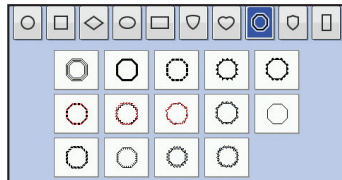
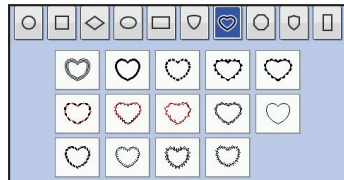
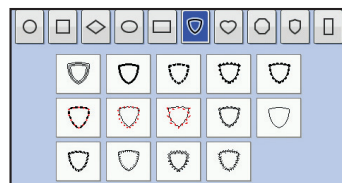
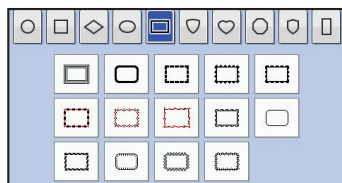
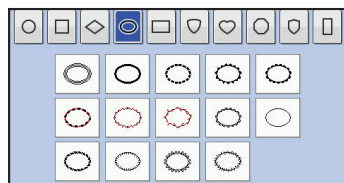
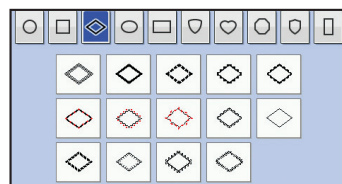
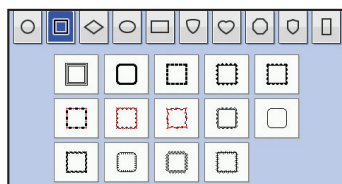
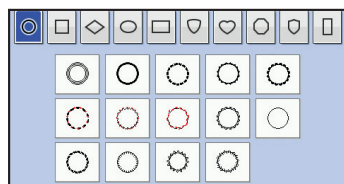
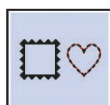

Embroidery Pattern Color Change Table

Tableau de changement de couleur des motifs de broderie
 Tabella di cambiamento colori degli schemi di ricamo
 Tabela de alteração de cor do padrão de bordado

Stickmuster-Farbtabelle

Kleurwijzigingstabel voor de borduurpatronen
 Tabla de cambio de color para patrones de bordado
 Таблицы цветов нитей для вышивок

◆ Embroidery patterns

◆ Motifs de broderie

◆ Schemi di ricamo

◆ Padrões de bordado

◆ Stickmuster

◆ Borduurpatronen

◆ Patrones de bordado

◆ Рисунки для вышивания



- "Four Seasons" designs
- Motifs « Quatre saisons »
- Disegni "Quattro stagioni"
- Desenhos "Quatro estações"

- Designs „Vier Jahreszeiten“
- "Vier seizoenen" ontwerpen
- Diseños "Cuatro estaciones"
- Рисунки "Четыре времени года"

No.1 13 min

Order to embroider
 Stickreihenfolge
 Séquence pour broder
 Borduurvolgorde
 Sequenza operazioni di ricamo
 Orden para el bordador
 Ordem para bordar
 Порядок вышивания

1	(124)
2	(001)
3	(086)
4	(001)
5	(017)
6	(612)
7	(085)
8	(205)
9	(019)
10	(900)

Embroidery thread color
 Stickgarnfarbe
 Couleur du fil de broderie
 Kleur borduurdraad
 Colore filo ricamo
 Color del hilo de bordado
 Cor da linha de bordar
 Цвет нити для вышивания

Time required for embroidering
 Zeitaufwand beim Stickten
 Durée requise pour broder
 Tijd benodigd voor het borduren
 Tempo di ricamo necessario
 Tiempo requerido para el bordado
 Tempo necessário para bordar
 Время, необходимое для вышивания

Embroidery thread color number
 Stickgarn-Farbnummer
 Numéro de couleur du fil de broderie
 Kleurnummer borduurdraad
 Numero colori filo per ricamo
 Número de color del hilo de bordado
 Número da cor da linha de bordar
 Номер цвета нити для вышивания

Embroidery size
 Größe der Stickerei
 Taille de la broderie
 Borduurgrootte
 Dimensioni del ricamo
 Tecla de tamaño
 Tamanho do bordado
 Размер вышивки

↓ 67.2 mm
 ↔ 66.3 mm

No.8 7 min

1	(502)
2	(812)
3	(079)
4	(328)
5	(330)
6	(126)
7	(206)
8	(328)

↓ 40.8 mm
 ↔ 83.1 mm

No.9 15 min

1	(502)
2	(513)
3	(812)
4	(348)
5	(126)
6	(206)
7	(348)
8	(843)

↓ 57.7 mm
 ↔ 104.2 mm

No.10 12 min

1	(124)
2	(513)
3	(005)
4	(079)
5	(086)
6	(206)

↓ 90.9 mm
 ↔ 90.5 mm

No.11 9 min

1	(406)
2	(810)
3	(085)
4	(202)

↓ 66.0 mm
 ↔ 99.7 mm

No.12 20 min

1	(399)
2	(337)
3	(001)
4	(017)
5	(405)

↓ 150.3 mm
 ↔ 112.8 mm

No.2 11 min

1	(027)
2	(612)
3	(070)
4	(502)
5	(019)
6	(085)
7	(206)
8	(086)
9	(001)
10	(070)

↓ 52.4 mm
 ↔ 63.0 mm

No.5 6 min

1	(900)
2	(800)

↓ 145.6 mm
 ↔ 112.0 mm

No.6

13 min

1	(124)	7	(509)	13	(613)
2	(800)	8	(613)	14	(612)
3	(001)	9	(612)	15	(613)
4	(807)	10	(206)	16	(206)
5	(348)	11	(612)		
6	(206)	12	(509)		

↓ 56.0 mm ↔ 74.8 mm

No.3 3 min

1	(812)
2	(027)
3	(515)
4	(513)

↓ 27.7 mm
 ↔ 56.7 mm

No.4 5 min

1	(807)
2	(515)
3	(001)
4	(017)
5	(070)

↓ 61.6 mm
 ↔ 76.9 mm

No.7 1 min

1	(900)
2	(800)

↓ 20.4 mm
 ↔ 38.0 mm



No.13

27 min		
1 (420)	11 (420)	21 (085)
2 (017)	12 (086)	22 (086)
3 (086)	13 (807)	23 (807)
4 (807)	14 (085)	24 (085)
5 (085)	15 (612)	25 (807)
6 (612)	16 (804)	26 (612)
7 (804)	17 (206)	27 (804)
8 (206)	18 (807)	28 (206)
9 (807)	19 (420)	
10 (017)	20 (017)	
↓ 105.9 mm ↔ 158.6 mm		



No.14

15 min		
1 (509)	6 (502)	11 (001)
2 (206)	7 (509)	12 (017)
3 (001)	8 (086)	13 (086)
4 (124)	9 (502)	
5 (017)	10 (509)	
↓ 68.1 mm ↔ 98.3 mm		



No.15

43 min	
1 (509)	
2 (513)	
3 (502)	
4 (079)	
5 (001)	
6 (206)	
7 (208)	
8 (513)	
9 (502)	
10 (509)	
↓ 129.4 mm ↔ 131.5 mm	



No.16

14 min	
1 (001)	
2 (019)	
3 (205)	
4 (209)	
5 (085)	
6 (030)	
7 (900)	
8 (405)	
9 (339)	
↓ 76.5 mm ↔ 69.9 mm	



No.17

2 min	
1 (800)	
2 (019)	
3 (001)	
4 (420)	
↓ 28.9 mm ↔ 18.9 mm	



No.18

13 min	
1 (030)	
2 (209)	
3 (208)	
4 (206)	
5 (202)	
6 (900)	
↓ 50.9 mm ↔ 74.5 mm	



No.19

11 min	
1 (017)	
2 (001)	
3 (405)	
↓ 56.4 mm ↔ 70.0 mm	



No.20

10 min	
1 (030)	
↓ 76.8 mm ↔ 77.6 mm	



No.21

7 min	
1 (001)	
2 (005)	
3 (405)	
4 (800)	
5 (001)	
6 (817)	
↓ 50.2 mm ↔ 50.2 mm	



No.22

5 min	
1 (001)	7 (126)
2 (017)	8 (612)
3 (502)	9 (800)
4 (086)	10 (086)
5 (202)	11 (001)
6 (019)	
↓ 63.0 mm ↔ 29.7 mm	



No.23

10 min		
1 (030)	5 (005)	9 (001)
2 (019)	6 (017)	10 (405)
3 (001)	7 (019)	11 (030)
4 (405)	8 (206)	12 (017)
↓ 48.4 mm ↔ 91.4 mm		

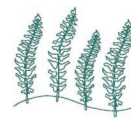

No.24

3 min	
1 (534)	
↓ 57.3 mm ↔ 64.8 mm	



No.25

21 min		
1 (019)	6 (086)	11 (085)
2 (515)	7 (206)	12 (086)
3 (513)	8 (019)	13 (206)
4 (209)	9 (515)	
5 (085)	10 (513)	
↓ 82.7 mm ↔ 85.3 mm		



No.26

18 min		
1 (001)	9 (001)	17 (001)
2 (323)	10 (323)	18 (323)
3 (513)	11 (513)	19 (507)
4 (507)	12 (507)	20 (513)
5 (513)	13 (513)	21 (206)
6 (206)	14 (206)	22 (208)
7 (208)	15 (208)	23 (328)
8 (328)	16 (328)	
↓ 76.3 mm ↔ 76.4 mm		



No.27

15 min	
1 (399)	
2 (534)	
3 (810)	
4 (399)	
5 (070)	
6 (614)	
7 (086)	
↓ 87.3 mm ↔ 89.2 mm	



No.28

19 min		
1 (202)	7 (202)	13 (202)
2 (406)	8 (406)	14 (406)
3 (019)	9 (019)	15 (019)
4 (513)	10 (513)	16 (513)
5 (515)	11 (515)	17 (515)
6 (519)	12 (519)	18 (519)
↓ 76.8 mm ↔ 130.5 mm		

Embroidery Pattern Color Change Table
 Stickmuster-Farbtabelle
 Tableau de changement de couleur des motifs de broderie
 Kleurwijzigingstabel voor de borduurpatronen
 Tabella di cambiamento colori degli schemi di ricamo
 Tabla de cambio de color para patrones de bordado
 Tabela de alteração de cor do padrão de bordado
 Таблицы цветов нитей для вышивок



No.29

15 min		
1 (509)	5 (328)	9 (206)
2 (030)	6 (337)	10 (126)
3 (206)	7 (323)	
4 (126)	8 (017)	
↓ 73.2 mm ↔ 93.0 mm		



No.34

12 min		
1 (214)	5 (515)	9 (612)
2 (323)	6 (513)	10 (620)
3 (339)	7 (209)	11 (339)
4 (030)	8 (208)	
↓ 52.8 mm ↔ 69.3 mm		



No.40

18 min	
1 (517)	
2 (323)	
3 (214)	
4 (348)	
5 (800)	
6 (214)	
7 (330)	
8 (030)	
9 (214)	
↓ 88.9 mm ↔ 112.0 mm	



No.30

44 min		
1 (507)	7 (107)	13 (001)
2 (534)	8 (202)	14 (017)
3 (507)	9 (206)	15 (800)
4 (001)	10 (507)	16 (107)
5 (017)	11 (534)	17 (202)
6 (800)	12 (507)	18 (206)
↓ 123.2 mm ↔ 120.6 mm		



No.35

7 min		
1 (010)	5 (205)	9 (405)
2 (027)	6 (900)	10 (030)
3 (001)	7 (030)	
4 (620)	8 (339)	
↓ 60.6 mm ↔ 68.2 mm		



No.41

13 min	
1 (307)	
2 (517)	
3 (513)	
4 (515)	
5 (612)	
6 (807)	
7 (517)	
8 (812)	
↓ 74.3 mm ↔ 75.8 mm	



No.36

3 min	
1 (214)	
2 (800)	
3 (339)	
↓ 22.0 mm ↔ 81.2 mm	



No.31

17 min	
1 (001)	
2 (843)	
3 (328)	
4 (323)	
5 (058)	
6 (900)	
↓ 93.1 mm ↔ 52.7 mm	



No.37

7 min	
1 (328)	
2 (323)	
3 (415)	
4 (339)	
5 (517)	
6 (307)	
↓ 45.8 mm ↔ 53.4 mm	



No.32

25 min	
1 (205)	
2 (900)	
3 (707)	
4 (001)	
5 (707)	
6 (005)	
7 (070)	
8 (030)	
9 (900)	
↓ 77.5 mm ↔ 74.1 mm	



No.38

10 min	
1 (348)	
2 (337)	
3 (330)	
4 (517)	
5 (214)	
6 (323)	
7 (107)	
↓ 75.0 mm ↔ 76.2 mm	



No.33

3 min	
1 (058)	
2 (209)	
3 (202)	
4 (323)	
5 (513)	
6 (515)	
↓ 30.1 mm ↔ 33.0 mm	



No.39

4 min	
1 (107)	
↓ 79.2 mm ↔ 79.2 mm	



No.42

26 min		
1 (307)	8 (812)	15 (612)
2 (517)	9 (307)	16 (812)
3 (513)	10 (517)	17 (612)
4 (515)	11 (513)	18 (807)
5 (807)	12 (515)	19 (812)
6 (517)	13 (807)	
7 (612)	14 (517)	
↓ 106.6 mm ↔ 106.8 mm		



No.43

42 min		
1 (399)	12 (328)	23 (339)
2 (328)	13 (517)	24 (542)
3 (206)	14 (206)	25 (517)
4 (337)	15 (339)	26 (058)
5 (339)	16 (337)	27 (399)
6 (517)	17 (542)	28 (206)
7 (328)	18 (058)	29 (517)
8 (058)	19 (542)	30 (339)
9 (542)	20 (399)	31 (328)
10 (399)	21 (328)	32 (058)
11 (058)	22 (206)	33 (542)
↓ 148.1 mm ↔ 114.0 mm		



No.44

15 min		
1 (348)	6 (058)	11 (058)
2 (214)	7 (208)	12 (348)
3 (126)	8 (214)	13 (339)
4 (208)	9 (126)	
5 (513)	10 (348)	

↓ 55.9 mm ↔ 122.9 mm



No.45

38 min		
1 (348)	12 (348)	23 (517)
2 (214)	13 (314)	24 (348)
3 (515)	14 (333)	25 (214)
4 (214)	15 (328)	26 (515)
5 (333)	16 (323)	27 (328)
6 (517)	17 (515)	28 (323)
7 (323)	18 (214)	29 (058)
8 (058)	19 (517)	30 (214)
9 (348)	20 (323)	
10 (515)	21 (348)	
11 (517)	22 (333)	

↓ 123.4 mm ↔ 123.6 mm



No.46

20 min		
1 (800)	6 (843)	11 (079)
2 (620)	7 (307)	12 (800)
3 (124)	8 (515)	13 (620)
4 (079)	9 (339)	14 (515)
5 (001)	10 (124)	

↓ 72.4 mm ↔ 95.5 mm



No.47

12 min		
1 (406)	5 (513)	9 (086)
2 (507)	6 (612)	10 (328)
3 (513)	7 (019)	11 (800)
4 (205)	8 (001)	12 (205)

↓ 56.1 mm ↔ 71.7 mm



No.48

4 min	
1 (323)	2 (208)
3 (507)	4 (800)

↓ 49.4 mm

↔ 40.2 mm



No.49

8 min	
1 (001)	2 (017)
3 (206)	4 (807)
5 (612)	6 (515)

↓ 54.5 mm

↔ 76.3 mm



No.50

9 min	
1 (405)	2 (328)
3 (107)	

↓ 88.2 mm

↔ 92.2 mm



No.51

6 min	
1 (001)	4 (214)
2 (800)	5 (209)
3 (817)	6 (900)

↓ 60.8 mm ↔ 30.4 mm



No.52

10 min	
1 (214)	2 (800)

↓ 96.2 mm

↔ 61.3 mm



No.53

6 min	
1 (030)	

↓ 77.8 mm

↔ 75.2 mm



No.54

2 min	
1 (214)	2 (509)
3 (800)	

↓ 64.9 mm

↔ 21.2 mm



No.55

12 min	
1 (058)	2 (515)
3 (800)	4 (206)
5 (323)	6 (058)
7 (534)	

↓ 56.0 mm

↔ 89.4 mm



No.56

10 min	
1 (507)	2 (328)
3 (001)	4 (800)
5 (328)	

↓ 52.8 mm

↔ 98.5 mm



No.57

16 min	
1 (328)	2 (348)
3 (126)	4 (206)
5 (107)	6 (001)
7 (507)	8 (328)
9 (107)	

↓ 92.4 mm

↔ 90.7 mm



No.58

9 min		
1 (542)	5 (542)	9 (415)
2 (323)	6 (323)	10 (323)
3 (415)	7 (415)	11 (406)
4 (323)	8 (323)	12 (205)

↓ 91.6 mm ↔ 90.1 mm



No.59

12 min		
1 (058)	5 (001)	9 (019)
2 (307)	6 (058)	10 (030)
3 (206)	7 (507)	11 (017)
4 (019)	8 (800)	

↓ 75.1 mm ↔ 100.1 mm



No.60

22 min	
1 (399)	2 (348)
3 (507)	4 (800)
5 (348)	6 (507)
7 (800)	8 (348)

↓ 95.8 mm

↔ 102.3 mm

Embroidery Pattern Color Change Table
Stickmuster-Farbtabelle
Tableau de changement de couleur des motifs de broderie
Kleurwijzigingstabel voor de borduurpatronen
Tabella di cambiamento colori degli schemi di ricamo
Tabla de cambio de color para patrones de bordado
Tabela de alteração de cor do padrão de bordado
Таблицы цветов нитей для вышивок

- "Other" designs
- « Autres » motifs
- Disegni "Vari"
- "Outros" desenhos

- Designs „Sonstige“
- "Andere" ontwerpen
- "Otros" diseños
- Другие рисунки

No.61 **9 min**



1	(614)
2	(620)
3	(405)
↓	82.4 mm
↔	91.2 mm

No.65 **8 min**



1	(019)
2	(017)
3	(019)
↓	69.9 mm
↔	67.1 mm

★ No.69 **4 min / 2 min**



1	(707)
↓	75.0 mm
L:	↔ 43.3 mm
S:	↓ 45.9 mm
	↔ 26.9 mm

No.62 **5 min**



1	(399)
2	(808)
3	(509)
↓	42.5 mm
↔	100.9 mm

★ No.66 **38 min / 19 min**



1	(843)
2	(614)
3	(517)
4	(843)
5	(517)
6	(843)
7	(517)
8	(843)
9	(614)
↓	154.1 mm
L:	↔ 118.7 mm
S:	↓ 96.6 mm
	↔ 73.4 mm

No.70 **8 min**



1	(519)
2	(704)
3	(800)
4	(542)
5	(519)
6	(704)
↓	84.0 mm
↔	59.7 mm

★ No.63 **8 min / 4 min**



1	(843)
2	(399)
3	(800)
↓	99.0 mm
L:	↔ 151.0 mm
S:	↓ 58.6 mm
	↔ 89.0 mm

No.67 **10 min**



1	(328)
2	(900)
3	(328)
4	(900)
↓	55.1 mm
↔	45.9 mm

No.71 **22 min**



1	(900)
2	(704)
3	(800)
4	(005)
5	(900)
6	(704)
↓	140.5 mm
↔	119.1 mm

No.64 **11 min**



1	(001)
2	(328)
3	(406)
4	(328)
5	(019)
↓	93.0 mm
↔	70.6 mm

No.68 **11 min**



1	(107)
↓	68.2 mm
↔	77.3 mm

No.72 **26 min**



1	(001)
2	(817)
3	(900)
4	(001)
5	(030)
↓	120.9 mm
↔	99.8 mm

Patterns marked with ★ are in large and small sizes. Make your selection prior to touching embroidery.
 Mit ★ markierte Muster gibt es in großen und kleinen Größen. Treffen Sie Ihre Auswahl, bevor Sie Stickerei berühren.
 Les motifs marqués d'une ★ sont disponibles en grande et petite tailles. Effectuez votre sélection avant d'appuyer sur broderie.
 Patronen die zijn gemarkeerd met ★ zijn beschikbaar in groot en klein formaat. Maak uw keuze voordat u de borduurtoets aanraakt.
 I disegni contrassegnati da ★ sono disponibili in dimensioni grandi e piccole. Selezionare le dimensioni desiderate prima di toccare il ricamo.
 Los patrones marcados con ★ están disponibles en tamaño grande y pequeño. Realice su selección antes de tocar el bordado.
 Os padrões marcados com ★ estão disponíveis em tamanhos grande e pequeno. Faça a escolha antes de tocar o bordado.
 Рисунки, отмеченные знаком ★, имеются в большом и малом размерах. Выберите необходимый.

◆ Brother “Exclusives” Trend designs

◆ Motifs tendance Brother « exclusifs »

◆ Disegni Tendenza “Esclusivi” Brother

◆ Desenhos modernos “exclusivos” da Brother

◆ Brother-„Auswahl“: Modische Designs

◆ “Exclusief” trendontwerpen van Brother

◆ Diseños de tendencias “exclusivos” de Brother

◆ Brother “Эксклюзив” стильные дизайны



No.1	28 min
1	■ (800)
↕	276.0 mm
↔	165.8 mm



No.4	84 min		
1	■ (001)	17	■ (017)
2	■ (399)	18	■ (001)
3	■ (405)	19	■ (405)
4	■ (017)	20	■ (017)
5	■ (399)	21	■ (399)
6	■ (001)	22	■ (001)
7	■ (405)	23	■ (399)
8	■ (399)	24	■ (001)
9	■ (017)	25	■ (405)
10	■ (001)	26	■ (017)
11	■ (399)	27	■ (001)
12	■ (405)	28	■ (405)
13	■ (017)	29	■ (017)
14	■ (405)	30	■ (405)
15	■ (001)	31	■ (399)
16	■ (399)	32	■ (001)
↕ 264.0 mm ↔ 164.4 mm			



No.2	29 min				
1	■ (900)	7	■ (328)	13	■ (415)
2	■ (534)	8	■ (509)	14	■ (507)
3	■ (420)	9	■ (208)	15	■ (070)
4	■ (509)	10	■ (534)	16	■ (206)
5	■ (507)	11	■ (515)	17	■ (900)
6	■ (415)	12	■ (517)		
↕ 181.9 mm ↔ 169.4 mm					



No.5	12 min
1	■ (330)
↕	231.6 mm
↔	138.4 mm



No.3	39 min				
1	■ (206)	6	■ (810)	11	■ (086)
2	■ (502)	7	■ (607)	12	■ (502)
3	■ (607)	8	■ (707)	13	■ (707)
4	■ (086)	9	■ (206)		
5	■ (707)	10	■ (607)		
↕ 150.3 mm ↔ 146.3 mm					

Embroidery Pattern Color Change Table
Stickmuster-Farbtabelle
Tableau de changement de couleur des motifs de broderie
Kleurwijzigingstabel voor de borduurpatronen
Tabella di cambiamento colori degli schemi di ricamo
Tabla de cambio de color para patrones de bordado
Tabela de alteração de cor do padrão de bordado
Таблицы цветов нитей для вышивок

● No.6

12 min	
1	■ (900)
↕	209.6 mm
↔	92.3 mm



No.9

51 min	
1	■ (124)
2	■ (399)
3	■ (807)
4	■ (086)
5	■ (399)
6	■ (001)
7	■ (086)
8	■ (807)
9	■ (124)
10	■ (399)
11	■ (807)
12	■ (124)
13	■ (086)
14	■ (001)
15	■ (086)
16	■ (807)
17	■ (399)
18	■ (001)
19	■ (086)
20	■ (807)
21	■ (124)
22	■ (086)
23	■ (399)
24	■ (807)
25	■ (124)
26	■ (086)
↕	275.6 mm
↔	152.4 mm



No.7

5 min	
1	■ (607)
2	■ (333)
3	■ (348)
↕	29.6 mm
↔	94.0 mm

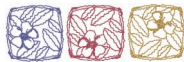

● No.8

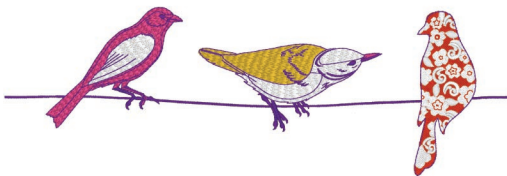

32 min	
1	■ (086)
2	■ (001)
3	■ (613)
4	■ (614)
5	■ (001)
6	■ (208)
7	■ (086)
8	■ (613)
9	■ (614)
10	■ (030)
11	■ (001)
12	■ (613)
13	■ (030)
↕	266.6 mm
↔	89.1 mm

No.10

49 min	
1	■ (001)
2	■ (420)
3	■ (406)
4	■ (542)
5	■ (399)
6	■ (420)
7	■ (001)
8	■ (420)
9	■ (406)
10	■ (542)
11	■ (399)
12	■ (542)
13	■ (399)
14	■ (406)
15	■ (420)
16	■ (399)
17	■ (406)
18	■ (542)
19	■ (420)
20	■ (406)
21	■ (542)
22	■ (406)
↕	257.0 mm
↔	173.8 mm



Patterns marked with ● have been rotated. Check your design placement prior to embroidering.

Muster, die mit ● gekennzeichnet sind, wurden gedreht. Überprüfen Sie die Platzierung Ihres Designs, bevor Sie mit Sticken beginnen.

Les motifs signalés par ● ont été pivotés. Vérifiez l'emplacement de votre motif avant de commencer à broder.

Patronen die zijn gemarkeerd met ● zijn gedraaid. Controleer de plaats van uw ontwerp voordat u gaat borduren.

I disegni contrassegnati dal simbolo ● appaiono ruotati. Prima di procedere al ricamo, verificare la posizione del disegno.

Los patrones marcados con ● se han girado. Compruebe la colocación del diseño antes de bordar.

Os padrões marcados com ● foram invertidos. Verifique o posicionamento do seu desenho antes de bordar.

Рисунки, отмеченные знаком ●, повернуты. Проверьте расположение рисунка перед началом вышивания.

◆ Brother “Exclusives” Vintage designs

◆ Motifs classiques Brother « exclusifs »

◆ Disegni Vintage “Esclusivi” Brother

◆ Desenhos clássicos “exclusivos” da Brother

◆ Brother-„Auswahl“: Klassische Designs

◆ “Exclusief” nostalgische ontwerpen van Brother

◆ Diseños de época “exclusivos” de Brother

◆ Brother “Эксклюзив” винтажные дизайны



● No.1



68 min			
1 (348)	9 (126)	17 (348)	25 (328)
2 (333)	10 (348)	18 (333)	26 (843)
3 (328)	11 (869)	19 (328)	27 (124)
4 (843)	12 (328)	20 (843)	28 (079)
5 (124)	13 (333)	21 (124)	29 (333)
6 (079)	14 (843)	22 (348)	30 (869)
7 (333)	15 (126)	23 (869)	31 (126)
8 (869)	16 (124)	24 (333)	
↓ 272.4 mm ↔ 160.6 mm			

No.3

45 min

1	(406)
↓	285.8 mm
↔	133.8 mm



● No.2



78 min			
1 (807)	11 (517)	21 (333)	31 (843)
2 (333)	12 (333)	22 (843)	32 (019)
3 (328)	13 (328)	23 (001)	33 (517)
4 (085)	14 (843)	24 (079)	34 (328)
5 (843)	15 (807)	25 (843)	35 (807)
6 (328)	16 (517)	26 (085)	36 (328)
7 (085)	17 (079)	27 (517)	37 (085)
8 (807)	18 (328)	28 (328)	38 (843)
9 (328)	19 (001)	29 (001)	39 (085)
10 (001)	20 (517)	30 (017)	40 (328)
↓ 263.2 mm ↔ 164.2 mm			

No.4

26 min

1	(107)
2	(085)
3	(086)
4	(406)
5	(513)
6	(017)
7	(607)
8	(406)
9	(513)
10	(017)
11	(607)
12	(406)
13	(513)
14	(017)
15	(607)
16	(085)
17	(086)
18	(107)
19	(406)
20	(399)
↓	287.0 mm
↔	170.5 mm



Embroidery Pattern Color Change Table
Stickmuster-Farbtabelle
Tableau de changement de couleur des motifs de broderie
Kleurwijzigingstabel voor de borduurpatronen
Tabella di cambiamento colori degli schemi di ricamo
Tabla de cambio de color para patrones de bordado
Tabela de alteração de cor do padrão de bordado
Таблицы цветов нитей для вышивок



No.5		9 min	
1	□ (001)	□ (001)	
2	■ (348)	■ (348)	
3	■ (070)	■ (070)	
4	□ (001)	□ (001)	
5	■ (348)	■ (348)	
6	■ (070)	■ (070)	
↕		82.0 mm	
↔		91.8 mm	



No.7		14 min	
1	■ (800)	■ (800)	
2	■ (534)	■ (534)	
3	■ (405)	■ (405)	
4	■ (348)	■ (348)	
5	■ (058)	■ (058)	
↕		41.6 mm	
↔		74.6 mm	



No.9		9 min	
1	■ (517)	■ (517)	
2	■ (206)	■ (206)	
3	■ (323)	■ (323)	
4	■ (333)	■ (333)	
↕		44.1 mm	
↔		103.0 mm	



No.6		17 min	
1	■ (800)	■ (800)	
2	■ (534)	■ (534)	
3	■ (405)	■ (405)	
4	■ (800)	■ (800)	
5	■ (348)	■ (348)	
6	■ (058)	■ (058)	
↕		81.2 mm	
↔		57.2 mm	



No.8		8 min	
1	■ (517)	■ (517)	
2	■ (010)	■ (010)	
3	■ (206)	■ (206)	
4	■ (323)	■ (323)	
5	■ (333)	■ (333)	
↕		60.5 mm	
↔		66.1 mm	



No.10		12 min	
1	■ (515)	■ (515)	
2	■ (415)	■ (415)	
3	■ (399)	■ (399)	
4	■ (124)	■ (124)	
5	■ (085)	■ (085)	
6	■ (086)	■ (086)	
7	■ (415)	■ (415)	
8	■ (202)	■ (202)	
↕		123.3 mm	
↔		64.0 mm	

◆ Brother “Exclusives” Japanese designs

◆ Motifs japonais Brother « exclusifs »

◆ Disegni giapponesi “Esclusivi” Brother

◆ Desenhos japoneses “exclusivos” da Brother

◆ Brother-„Auswahl“: Japanische Designs

◆ “Exclusief” Japanse ontwerpen van Brother

◆ Diseños japoneses “exclusivos” de Brother

◆ Brother “Эксклюзив” японские дизайны



● No.1

No.1		99 min					
1	■ (208)	14	■ (202)	27	■ (017)	40	■ (900)
2	■ (509)	15	■ (017)	28	■ (509)	41	■ (800)
3	■ (001)	16	■ (509)	29	■ (607)	42	■ (001)
4	■ (202)	17	■ (800)	30	■ (800)	43	■ (208)
5	■ (017)	18	■ (900)	31	■ (900)	44	■ (607)
6	■ (509)	19	■ (001)	32	■ (001)	45	■ (017)
7	■ (208)	20	■ (017)	33	■ (202)	46	■ (509)
8	■ (079)	21	■ (800)	34	■ (208)	47	■ (800)
9	■ (800)	22	■ (509)	35	■ (900)	48	■ (001)
10	■ (900)	23	■ (900)	36	■ (509)	49	■ (208)
11	■ (001)	24	■ (001)	37	■ (017)	50	■ (607)
12	■ (079)	25	■ (079)	38	■ (079)	51	■ (017)
13	■ (607)	26	■ (202)	39	■ (800)	52	■ (509)
↕						287.2 mm ↔ 172.6 mm	

Patterns marked with ● have been rotated. Check your design placement prior to embroidering.

Muster, die mit ● gekennzeichnet sind, wurden gedreht. Überprüfen Sie die Platzierung Ihres Designs, bevor Sie mit Sticken beginnen.

Les motifs signalés par ● ont été pivotés. Vérifiez l'emplacement de votre motif avant de commencer à broder.

Patronen die zijn gemarkeerd met ● zijn gedraaid. Controleer de plaats van uw ontwerp voordat u gaat borduren.

I disegni contrassegnati dal simbolo ● appaiono ruotati. Prima di procedere al ricamo, verificare la posizione del disegno.

Los patrones marcados con ● se han girado. Compruebe la colocación del diseño antes de bordar.

Os padrões marcados com ● foram invertidos. Verifique o posicionamento do seu desenho antes de bordar.

Рисунки, отмеченные знаком ●, повернуты. Проверьте расположение рисунка перед началом вышивания.



No.2 **94 min**

1	(030)	22	(542)	43	(001)
2	(507)	23	(612)	44	(307)
3	(348)	24	(406)	45	(208)
4	(323)	25	(208)	46	(328)
5	(001)	26	(900)	47	(406)
6	(542)	27	(328)	48	(542)
7	(612)	28	(406)	49	(900)
8	(323)	29	(030)	50	(030)
9	(406)	30	(507)	51	(507)
10	(208)	31	(001)	52	(399)
11	(900)	32	(348)	53	(001)
12	(704)	33	(612)	54	(612)
13	(328)	34	(542)	55	(542)
14	(406)	35	(208)	56	(208)
15	(307)	36	(323)	57	(307)
16	(030)	37	(406)	58	(348)
17	(507)	38	(900)	59	(420)
18	(001)	39	(030)	60	(323)
19	(399)	40	(507)	61	(406)
20	(348)	41	(328)	62	(900)
21	(323)	42	(323)		

↓ 244.4 mm ↔ 123.5 mm



No.6 **9 min**

1	(415)
2	(399)
3	(323)
4	(800)
5	(005)
6	(399)
7	(328)

↓ 63.2 mm
↔ 117.0 mm



No.7 **18 min**

1	(001)	6	(030)
2	(058)	7	(209)
3	(515)	8	(001)
4	(517)	9	(399)
5	(800)	10	(208)

↓ 84.0 mm ↔ 78.2 mm



No.3 **73 min**

1	(030)	8	(214)	15	(328)
2	(515)	9	(328)	16	(810)
3	(019)	10	(030)	17	(612)
4	(328)	11	(612)	18	(030)
5	(810)	12	(206)	19	(348)
6	(206)	13	(810)	20	(206)
7	(348)	14	(348)	21	(348)

↓ 152.1 mm ↔ 151.0 mm



No.8 **18 min**

1	(328)
2	(058)
3	(515)
4	(519)
5	(330)
6	(058)
7	(337)
8	(348)
9	(079)
10	(086)
11	(058)
12	(010)

↓ 140.6 mm
↔ 62.3 mm

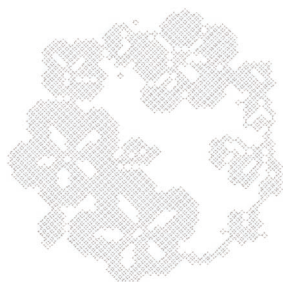

No.4 **15 min**

1	(001)
---	-------

↓ 145.1 mm
↔ 144.9 mm



No.5 **21 min**

1	(337)	8	(337)
2	(019)	9	(019)
3	(614)	10	(614)
4	(612)	11	(612)
5	(507)	12	(507)
6	(206)	13	(206)
7	(348)	14	(348)

↓ 85.8 mm ↔ 91.3 mm











No.9 **29 min**

1	(001)
2	(399)
3	(534)
4	(502)
5	(070)
6	(406)
7	(070)
8	(399)
9	(206)
10	(070)
11	(406)
12	(534)
13	(502)

↓ 128.2 mm
↔ 139.2 mm



Embroidery Pattern Color Change Table
 Stickmuster-Farbtabelle
 Tableau de changement de couleur des motifs de broderie
 Kleurwijzigingstabel voor de borduurpatronen
 Tabella di cambiamento colori degli schemi di ricamo
 Tabla de cambio de color para patrones de bordado
 Tabela de alteração de cor do padrão de bordado
 Таблицы цветов нитей для вышивок

No.10 **12 min**

1		(333)
2		(607)
3		(206)
4		(399)
5		(517)
6		(612)
7		(337)
8		(017)
9		(005)
↓		84.9 mm
↔		86.4 mm





No.13 **36 min**

1		(900)
2		(030)
↓		252.6 mm
↔		152.5 mm



Taishi: Ambition
 Ambition
 Ambition
 Ambition
 Ambition
 Ambition
 Ambition
 Ambition
 Мечта



No.11 **44 min**

1		(900)
2		(030)
↓		251.8 mm
↔		175.8 mm



Kizuna: Band
 Band
 Bande
 Band
 Banda
 Banda
 Laço
 Связь



No.14 **25 min**

1		(900)
2		(030)
↓		184.7 mm
↔		104.6 mm



Seiko: Success
 Erfolg
 Succès
 Succes
 Successo
 Éxito
 Sucesso
 Успех



No.12 **19 min**

1		(900)
2		(030)
↓		122.4 mm
↔		142.8 mm



Iwai: Celebration
 Feier
 Festivités
 Feest
 Celebrazione
 Celebración
 Celebração
 Праздник

No.15 **19 min**

1		(900)
2		(030)
↓		178.0 mm
↔		93.2 mm



Sozo: Creation
 Kreation
 Création
 Schepping
 Creazione
 Creación
 Criação
 Творчество

Patterns No.11 – No.15, are designed by Taisen Okamoto.
 Muster Nr.11 – Nr. 15 wurden von Taisen Okamoto entworfen.
 Les motifs 11 à 15 ont été conçus par Taisen Okamoto.
 De patronen 11 – 15 zijn ontwikkeld door Taisen Okamoto.
 I disegni dal N.11 al N. 15 sono stati realizzati da Taisen Okamoto.
 Los patrones del n° 11 al n° 15 han sido diseñados por Taisen Okamoto.
 Os padrões n° 11 a n° 15 foram desenvolvidos por Taisen Okamoto.
 Рисунки № 4–10 созданы Тайсен Окамото.

◆ Brother “Exclusives” Quilt designs

◆ Motifs piqués Brother « exclusifs »

◆ Disegni per trapuntatura “Esclusivi” Brother

◆ Desenhos de quilt “exclusivos” da Brother

◆ Brother-„Auswahl“: Quiltdesigns

◆ “Exclusief” quiltontwerpen van Brother

◆ Diseños de acolchado “exclusivos” de Brother

◆ Brother “Эксклюзив” дизайны для квилтинга

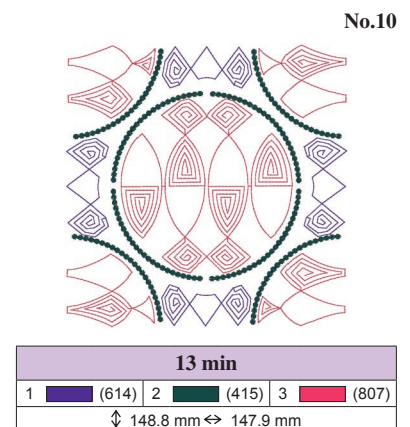
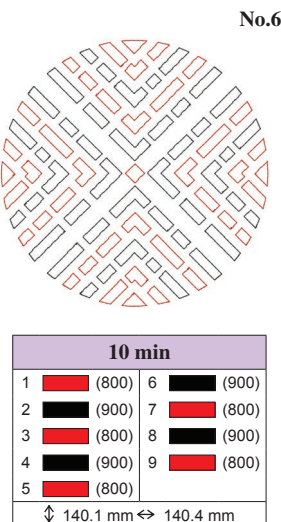
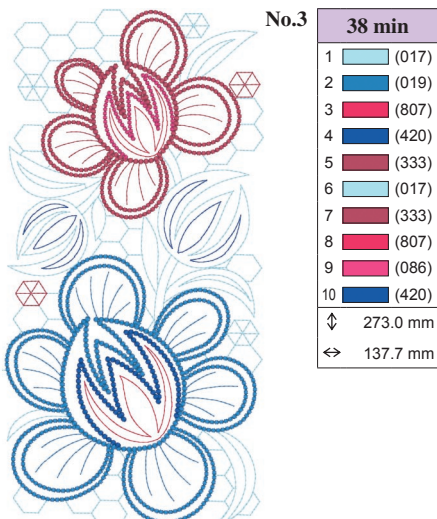
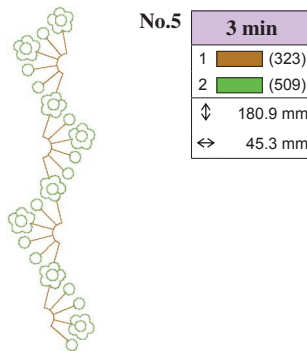
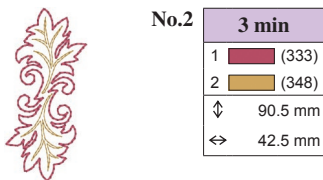
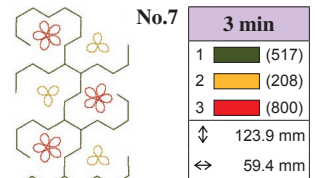
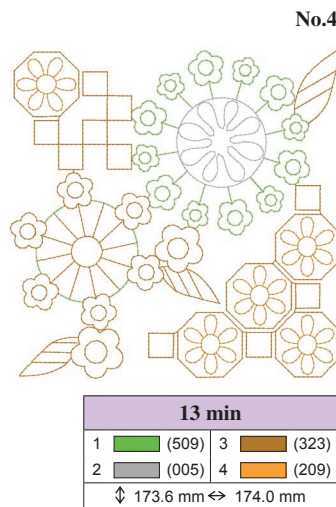
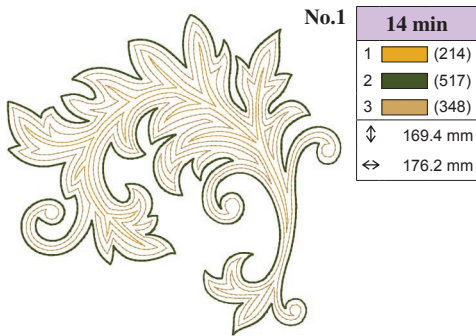
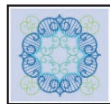

- ◆ Brother "Exclusives" New-Technique designs
- ◆ Nouveaux motifs techniques Brother « exclusifs »
- ◆ Disegni Nuova tecnica "Esclusivi" Brother
- ◆ Desenhos de novas técnicas "exclusivos" da Brother
- ◆ Brother-„Auswahl“: Designs „Neue Technik“
- ◆ "Exclusief" ontwerpen van Brother met nieuwe technieken
- ◆ Diseños de nuevas técnicas "exclusivos" de Brother
- ◆ Brother "Эксклюзив" дизайны в новой технике

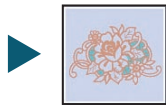

No.1

12 min	
1	■ (070)
2	■ (348)
↓	78.2 mm
↔	120.8 mm



No.2

12 min	
1	■ (070)
2	■ (348)
↓	64.4 mm
↔	145.3 mm



No.3

21 min	
1	■ (328)
2	■ (337)
3	■ (519)
4	■ (515)
5	■ (001)
6	■ (005)
↓	70.5 mm
↔	107.2 mm



No.4

49 min	
1	■ (808)
2	■ (812)
3	■ (513)
↓	226.6 mm
↔	109.8 mm

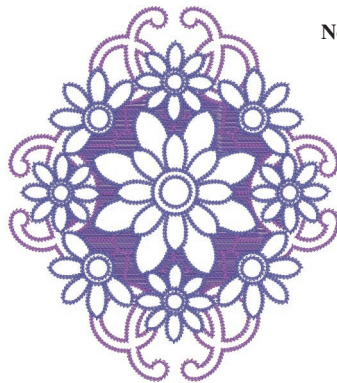

No.5

103 min					
1	■ (614)	2	■ (612)	3	■ (607)
↓ 197.5 mm ↔ 175.1 mm					



No.6

21 min	
1	■ (010)
↓	70.4 mm
↔	78.8 mm

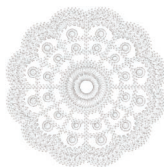

No.7

48 min	
1	■ (001)
↓	83.7 mm
↔	83.5 mm

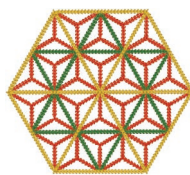

No.8

40 min	
1	■ (030)
2	■ (515)
3	■ (208)
↓	85.9 mm
↔	98.9 mm



Embroidering on water-soluble sheets without any fabric

Stickten auf wasserlöslicher Folie ohne Stoff

Broderie sur des feuilles hydrosolubles sans aucun tissu

Borduren op wateroplosbaar papier zonder textiel

Ricamo su pellicole solubili in acqua senza alcun tessuto

Bordado en láminas solubles en agua sin ninguna tela

Bordado em folhas solúveis em água sem nenhum tecido

Вышивание на водорастворимых листах без материала



No.9

9 min	
1	■ (019)
↓	17.3 mm
↔	96.0 mm



No.10

17 min	
1	■ (800)
↓	33.2 mm
↔	114.5 mm

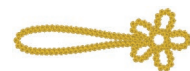

No.11

11 min	
1	■ (208)
↓	32.9 mm
↔	93.6 mm



No.12

39 min	
1	■ (328)
2	■ (399)
↓	107.4 mm
↔	112.6 mm

Refer to "3D combination motifs" on page 44 for detailed instruction.

Ausführliche Hinweise, siehe „3D-Kombinationsmotive“ auf Seite 44.

Reportez-vous à la section « Motifs de combinaison 3D » à la page 44 pour des instructions détaillées.

Uitvoeringaanwijzingen vindt u in "3D-combinatiemotieven" op p. 44.

Fare riferimento a "Motivi tridimensionali combinati" a pagina 44 per istruzioni dettagliate.

Consulte las instrucciones detalladas acerca de los "Motivos de combinación 3D" en la página 44.

Consulte os "motivos de combinações 3D" na página 44 para saber as instruções detalhadas.

Подробные инструкции см. в разделе "Комбинированные 3D вышивки" на с. 44.

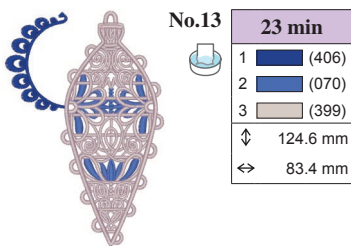

No.13		23 min
1	(406)	
2	(070)	
3	(399)	
↓	124.6 mm	
↔	83.4 mm	



No.14		14 min
1	(070)	
2	(399)	
↓	98.9 mm	
↔	39.3 mm	

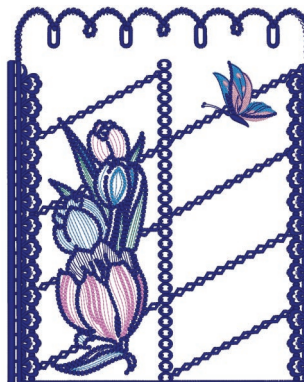

No.15		60 min
1	(019)	
2	(810)	
3	(534)	
4	(007)	
5	(019)	
6	(079)	
7	(007)	
↓	200.4 mm	
↔	161.7 mm	



Embroidering on water-soluble sheets without any fabric

Sticken auf wasserlöslicher Folie ohne Stoff

Broderie sur des feuilles hydrosolubles sans aucun tissu

Borduren op wateroplosbaar papier zonder textiel

Ricamo su pellicole solubili in acqua senza alcun tessuto

Bordado en láminas solubles en agua sin ninguna tela

Bordado em folhas solúveis em água sem nenhum tecido

Вышивание на водорастворимых листах без материала



Recommended for embroidering on thin fabric such as organza

Empfohlen zum Sticken auf dünnem Stoff wie Organza

Recommandé pour la broderie sur des tissus minces comme l'organza

Aanbevolen voor borduurwerk op dun materiaal zoals organza

Raccomandata per ricamo su tessuto sottile quale l'organza

Recomendado para bordar en tela fina como organza

Recomendado para bordado em tecido fino como organza

Рекомендуется для вышивания на тонких тканях (органза и т. п.)

Refer to "3D combination motifs" on page 44 for detailed instruction.

Ausführliche Hinweise, siehe „3D-Kombinationsmotive“ auf Seite 44.

Reportez-vous à la section « Motifs de combinaison 3D » à la page 44 pour des instructions détaillées.

Uitvoering aanwijzingen vindt u in "3D-combinatiemotieven" op p. 44.

Fare riferimento a "Motivi tridimensionali combinati" a pagina 44 per istruzioni dettagliate.

Consulte las instrucciones detalladas acerca de los "Motivos de combinación 3D" en la página 44.

Consulte os "motivos de combinações 3D" na página 44 para saber as instruções detalhadas.

Подробные инструкции см. в разделе "Комбинированные 3D вышивки" на с. 44.

◆ Brother "Exclusives" Zündt designs

◆ Motifs Zündt Design Brother « exclusifs »

◆ Disegni Zündt "Esclusivi" Brother

◆ Desenhos Zündt "exclusivos" da Brother

◆ Brother-„Auswahl“: Zündt-Designs

◆ "Exclusief" Zündt-ontwerpen van Brother

◆ Diseños Zündt "exclusivos" de Brother

◆ Brother "Эксклюзив" дизайны Zündt



No.1

57 min	
1	(214)
2	(206)
3	(126)
4	(800)
5	(206)
6	(126)
7	(800)
8	(086)
9	(214)
↓	250.8 mm
↔	170.8 mm



No.2

20 min			
1	(206)	6	(206)
2	(126)	7	(126)
3	(800)	8	(800)
4	(086)	9	(086)
5	(214)	10	(214)
↓ 180.0 mm		↔ 84.8 mm	



No.3

11 min	
1	(214)
↓	258.4 mm
↔	175.6 mm



No.4

4 min	
1	(214)
↓	175.8 mm
↔	83.8 mm

Embroidery Pattern Color Change Table
Stickmuster-Farbtabelle
Tableau de changement de couleur des motifs de broderie
Kleurwijzigingstabel voor de borduurpatronen
Tabella di cambiamento colori degli schemi di ricamo
Tabla de cambio de color para patrones de bordado
Tabela de alteração de cor do padrão de bordado
Таблицы цветов нитей для вышивок

No.5 **36 min**



1	(085)
2	(010)
3	(027)
4	(620)
5	(010)
6	(027)

↓ 175.6 mm
 ↔ 141.8 mm

No.6 **26 min**



1	(085)
2	(620)
3	(513)
4	(027)

↓ 184.6 mm
 ↔ 142.0 mm

No.7 **5 min**

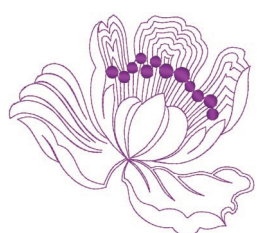

1	(620)
---	-------

↓ 116.4 mm
 ↔ 129.0 mm

No.8 **2 min**



1	(620)
---	-------

↓ 106.8 mm
 ↔ 113.4 mm

No.9



1	(070)	5	(126)
2	(328)	6	(010)
3	(513)	7	(323)
4	(612)		

↓ 175.0 mm ↔ 157.4 mm

No.10



32 min	
1	(085)
2	(614)
3	(502)
4	(810)
5	(206)
6	(209)
7	(810)
8	(085)
9	(214)
10	(323)

↓ 214.0 mm ↔ 95.6 mm

No.11 **17 min**



1	(085)
2	(614)
3	(502)
4	(810)
5	(206)
6	(209)
7	(810)
8	(085)
9	(214)

↓ 99.4 mm
 ↔ 97.8 mm

No.12 **3 min**



1	(502)
2	(810)
3	(085)
4	(614)

↓ 29.0 mm
 ↔ 66.2 mm

No.13



45 min	
1	(085)
2	(079)
3	(348)
4	(085)
5	(515)
6	(010)
7	(027)
8	(206)
9	(214)

↓ 163.8 mm ↔ 163.8 mm

No.14 **49 min**



1	(085)
2	(079)
3	(348)
4	(085)
5	(515)
6	(010)
7	(027)
8	(206)
9	(214)

↓ 276.6 mm
 ↔ 90.8 mm

No.15 **20 min**



1	(085)
2	(079)
3	(348)
4	(010)
5	(027)
6	(206)
7	(214)

↓ 100.4 mm
 ↔ 99.8 mm

Patterns No.1 - No.15, are designed by Zündt Design, Ltd.
 Muster Nr. 1 - Nr. 15 wurden entworfen von Zündt Design, Ltd.
 Les motifs n° 1 à 15 ont été créés par Zündt Design, Ltd.
 De patronen 1 - 15 zijn ontwikkeld door Zündt Design, Ltd.
 I disegni dal N.1 al N.15 sono stati realizzati da Zündt Design, Ltd.
 Los patrones del N° 1 - N° 15, han sido diseñados por Zündt Design, Ltd.
 Os padrões n° 1 a n°15, foram desenvolvidos por Zündt Design, Ltd.
 Рисунки с № 1 по № 15 созданы дизайнерами компании Zündt Design, Ltd.

◆ Floral alphabet patterns

◆ Motifs alphabet floral

◆ Alfabeto floreal

◆ Padrões florais de alfabeto

◆ Blumenalphabet

◆ Bloemletterpatronen

◆ Patrones alfabéticas en motivo floral

◆ Цветочные шрифты



No.1

24 min	
1	(328)
2	(804)
3	(612)
4	(079)
5	(807)
6	(513)
7	(502)
↓	145.1 mm
↔	125.7 mm



No.6

22 min	
1	(328)
2	(804)
3	(612)
4	(079)
5	(807)
6	(513)
7	(502)
↓	142.8 mm
↔	101.8 mm

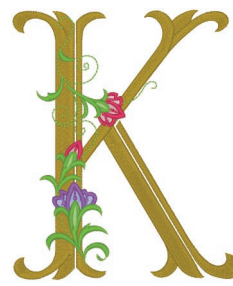

No.11

27 min	
1	(328)
2	(804)
3	(612)
4	(079)
5	(807)
6	(513)
7	(502)
↓	142.0 mm
↔	119.6 mm



No.2

27 min	
1	(328)
2	(804)
3	(612)
4	(079)
5	(807)
6	(513)
7	(502)
↓	140.9 mm
↔	108.1 mm



No.7

26 min	
1	(328)
2	(804)
3	(612)
4	(079)
5	(807)
6	(513)
7	(502)
↓	141.6 mm
↔	117.3 mm



No.12

20 min	
1	(328)
2	(804)
3	(612)
4	(079)
5	(807)
6	(513)
7	(502)
↓	144.9 mm
↔	107.0 mm



No.3

22 min	
1	(328)
2	(804)
3	(612)
4	(079)
5	(807)
6	(513)
7	(502)
↓	141.8 mm
↔	114.5 mm



No.8

30 min	
1	(328)
2	(804)
3	(612)
4	(079)
5	(807)
6	(513)
7	(502)
↓	141.7 mm
↔	121.6 mm



No.13

32 min	
1	(328)
2	(804)
3	(612)
4	(079)
5	(807)
6	(513)
7	(502)
↓	146.5 mm
↔	124.6 mm



No.4

26 min	
1	(328)
2	(804)
3	(612)
4	(079)
5	(807)
6	(513)
7	(502)
↓	141.2 mm
↔	108.3 mm



No.9

19 min	
1	(328)
2	(804)
3	(612)
4	(079)
5	(807)
6	(513)
7	(502)
↓	145.8 mm
↔	49.7 mm



No.14

27 min	
1	(328)
2	(804)
3	(612)
4	(079)
5	(807)
6	(513)
7	(502)
↓	147.0 mm
↔	116.8 mm



No.5

25 min	
1	(328)
2	(804)
3	(612)
4	(079)
5	(807)
6	(513)
7	(502)
↓	144.3 mm
↔	102.5 mm



No.10

20 min	
1	(328)
2	(804)
3	(612)
4	(079)
5	(807)
6	(513)
7	(502)
↓	144.5 mm
↔	82.3 mm



No.15

25 min	
1	(328)
2	(804)
3	(612)
4	(079)
5	(807)
6	(513)
7	(502)
↓	146.3 mm
↔	115.3 mm

Embroidery Pattern Color Change Table
Stickmuster-Farbtabelle
Tableau de changement de couleur des motifs de broderie
Kleurwijzigingstabel voor de borduurpatronen
Tabella di cambiamento colori degli schemi di ricamo
Tabla de cambio de color para patrones de bordado
Tabela de alteração de cor do padrão de bordado
Таблицы цветов нитей для вышивок

No.16 **23 min**



1	(328)
2	(804)
3	(612)
4	(079)
5	(807)
6	(513)
7	(502)

↓ 143.4 mm
↔ 99.6 mm

No.20 **24 min**



1	(328)
2	(804)
3	(612)
4	(079)
5	(807)
6	(513)
7	(502)

↓ 144.5 mm
↔ 118.4 mm

No.24 **25 min**



1	(328)
2	(804)
3	(612)
4	(079)
5	(807)
6	(513)
7	(502)

↓ 142.3 mm
↔ 115.9 mm

No.17 **27 min**



1	(328)
2	(804)
3	(612)
4	(079)
5	(807)
6	(513)
7	(502)

↓ 142.7 mm
↔ 118.2 mm

No.21 **24 min**



1	(328)
2	(804)
3	(612)
4	(079)
5	(807)
6	(513)
7	(502)

↓ 144.6 mm
↔ 118.5 mm

No.25 **22 min**



1	(328)
2	(804)
3	(612)
4	(079)
5	(807)
6	(513)
7	(502)

↓ 142.8 mm
↔ 116.3 mm

No.18 **28 min**



1	(328)
2	(804)
3	(612)
4	(079)
5	(807)
6	(513)
7	(502)

↓ 143.4 mm
↔ 112.5 mm

No.22 **24 min**



1	(328)
2	(804)
3	(612)
4	(079)
5	(807)
6	(513)
7	(502)

↓ 145.5 mm
↔ 121.5 mm

No.26 **26 min**



1	(328)
2	(804)
3	(612)
4	(079)
5	(807)
6	(513)
7	(502)

↓ 142.8 mm
↔ 92.9 mm

No.19 **28 min**



1	(328)
2	(804)
3	(612)
4	(079)
5	(807)
6	(513)
7	(502)

↓ 144.1 mm
↔ 99.4 mm

No.23 **32 min**



1	(328)
2	(804)
3	(612)
4	(079)
5	(807)
6	(513)
7	(502)

↓ 146.2 mm
↔ 124.8 mm

◆Example ◆Beispiel ◆Exemple ◆Voorbeeld
◆Esempio ◆Ejemplo ◆Example ◆Пример

No.27 **4 min**



1	(328)
2	(079)
3	(807)
4	(513)
5	(502)

↓ 51.9 mm
↔ 45.9 mm



No.28 **4 min**



1	(328)
2	(079)
3	(807)
4	(513)
5	(502)

↓ 51.7 mm
↔ 39.6 mm

No.29 **4 min**



1	(328)
2	(079)
3	(807)
4	(513)
5	(502)

↓ 52.2 mm
↔ 41.1 mm

No.30 **4 min**



1	(328)
2	(079)
3	(807)
4	(513)
5	(502)

↓ 51.9 mm
↔ 39.3 mm

No.31 **4 min**



1	(328)
2	(079)
3	(807)
4	(513)
5	(502)

↓ 53.1 mm
↔ 37.3 mm

No.32 **4 min**



1	(328)
2	(079)
3	(807)
4	(513)
5	(502)

↓ 52.1 mm
↔ 36.6 mm

No.33 4 min



1	(328)
2	(079)
3	(807)
4	(513)
5	(502)
↓	51.9 mm
↔	42.7 mm

No.37 5 min



1	(328)
2	(079)
3	(807)
4	(513)
5	(502)
↓	52.4 mm
↔	43.4 mm

No.41 4 min



1	(328)
2	(079)
3	(807)
4	(513)
5	(502)
↓	52.8 mm
↔	42.6 mm

No.45 4 min



1	(328)
2	(079)
3	(807)
4	(513)
5	(502)
↓	52.6 mm
↔	35.0 mm

No.49 5 min



1	(328)
2	(079)
3	(807)
4	(513)
5	(502)
↓	53.3 mm
↔	46.5 mm

No.34 5 min



1	(328)
2	(079)
3	(807)
4	(513)
5	(502)
↓	52.2 mm
↔	44.3 mm

No.38 3 min



1	(328)
2	(079)
3	(807)
4	(513)
5	(502)
↓	52.5 mm
↔	38.9 mm

No.42 4 min



1	(328)
2	(079)
3	(807)
4	(513)
5	(502)
↓	52.1 mm
↔	36.9 mm

No.46 4 min



1	(328)
2	(079)
3	(807)
4	(513)
5	(502)
↓	53.0 mm
↔	42.0 mm

No.50 4 min



1	(328)
2	(079)
3	(807)
4	(513)
5	(502)
↓	51.7 mm
↔	42.0 mm

No.35 4 min



1	(328)
2	(079)
3	(807)
4	(513)
5	(502)
↓	53.9 mm
↔	23.8 mm

No.39 6 min



1	(328)
2	(079)
3	(807)
4	(513)
5	(502)
↓	53.3 mm
↔	46.4 mm

No.43 4 min



1	(328)
2	(079)
3	(807)
4	(513)
5	(502)
↓	52.6 mm
↔	43.3 mm

No.47 4 min



1	(328)
2	(079)
3	(807)
4	(513)
5	(502)
↓	52.5 mm
↔	42.8 mm

No.51 4 min



1	(328)
2	(079)
3	(807)
4	(513)
5	(502)
↓	53.8 mm
↔	42.2 mm

No.36 3 min



1	(328)
2	(079)
3	(807)
4	(513)
5	(502)
↓	52.6 mm
↔	30.1 mm

No.40 5 min



1	(328)
2	(079)
3	(807)
4	(513)
5	(502)
↓	52.9 mm
↔	43.1 mm

No.44 4 min



1	(328)
2	(079)
3	(807)
4	(513)
5	(502)
↓	52.3 mm
↔	40.7 mm

No.48 4 min



1	(328)
2	(079)
3	(807)
4	(513)
5	(502)
↓	52.8 mm
↔	43.9 mm

No.52 4 min



1	(328)
2	(079)
3	(807)
4	(513)
5	(502)
↓	52.4 mm
↔	33.4 mm

No.53 2 min



1	(804)
2	(612)
3	(079)
4	(807)
5	(513)
6	(502)
↓	34.4 mm
↔	22.7 mm

No.55 4 min



1	(804)	3	(079)	5	(513)
2	(612)	4	(807)	6	(502)
↓ 39.3 mm ↔ 75.4 mm					

No.57 7 min



1	(804)	7	(804)	13	(079)
2	(612)	8	(612)	14	(807)
3	(079)	9	(079)	15	(513)
4	(807)	10	(807)	16	(502)
5	(513)	11	(513)		
6	(502)	12	(502)		
↓ 27.9 mm ↔ 121.9 mm					

No.54 2 min



1	(079)
2	(807)
3	(513)
4	(502)
↓	39.8 mm
↔	25.6 mm

No.56 7 min



1	(804)	5	(513)	9	(079)
2	(612)	6	(502)	10	(807)
3	(079)	7	(804)	11	(513)
4	(807)	8	(612)	12	(502)
↓ 23.4 mm ↔ 123.7 mm					

Embroidery Pattern Color Change Table
 Stickmuster-Farbtabelle
 Tableau de changement de couleur des motifs de broderie
 Kleurwijzigingstabel voor de borduurpatronen
 Tabella di cambiamento colori degli schemi di ricamo
 Tabla de cambio de color para patrones de bordado
 Tabela de alteração de cor do padrão de bordado
 Таблицы цветов нитей для вышивок



No. 58

13 min		
1 (079)	7 (513)	13 (079)
2 (807)	8 (502)	14 (807)
3 (513)	9 (079)	15 (513)
4 (502)	10 (807)	16 (502)
5 (079)	11 (513)	
6 (807)	12 (502)	
↕ 103.6 mm ↔ 94.9 mm		



No.60

5 min	
1 (513)	
2 (807)	
3 (513)	
4 (807)	
↕ 106.7 mm	
↔ 93.4 mm	



No.63

1 min	
1 (513)	
↕ 147.2 mm	
↔ 61.8 mm	



No.59

28 min		
1 (079)	17 (513)	33 (804)
2 (807)	18 (502)	34 (612)
3 (804)	19 (079)	35 (513)
4 (612)	20 (807)	36 (502)
5 (513)	21 (804)	37 (079)
6 (502)	22 (612)	38 (807)
7 (079)	23 (513)	39 (804)
8 (807)	24 (502)	40 (612)
9 (804)	25 (079)	41 (513)
10 (612)	26 (807)	42 (502)
11 (513)	27 (804)	43 (079)
12 (502)	28 (612)	44 (807)
13 (079)	29 (513)	45 (804)
14 (807)	30 (502)	46 (612)
15 (804)	31 (079)	47 (513)
16 (612)	32 (807)	48 (502)
↕ 218.4 mm ↔ 175.7 mm		



No.61

4 min	
1 (513)	
2 (807)	
3 (513)	
4 (807)	
↕ 42.6 mm	
↔ 142.0 mm	



No.64

8 min		
1 (804)	9 (079)	17 (513)
2 (612)	10 (807)	18 (502)
3 (079)	11 (513)	19 (804)
4 (807)	12 (502)	20 (612)
5 (513)	13 (804)	21 (079)
6 (502)	14 (612)	22 (807)
7 (804)	15 (079)	23 (513)
8 (612)	16 (807)	24 (502)
↕ 73.3 mm ↔ 72.8 mm		



No.62

15 min		
1 (513)	4 (807)	7 (513)
2 (807)	5 (513)	8 (807)
3 (513)	6 (807)	
↕ 216.6 mm ↔ 175.7 mm		

◆ Patterns for bobbin work

Bobbin work can only be performed in the "Embroidery Mode".

◆ Motifs pour le travail à la canette

Le travail à la canette ne peut être effectué qu'en « mode broderie ».

◆ Disegni per ricamo con spolina

Bobbin work può essere eseguito solo in "Modalità ricamo".

◆ Padrões de efeito decorativo com a bobina

O trabalho da bobina pode ser executado somente no "Modo Bordado".

◆ Stickmuster für Bobbin Work

Bobbin Work kann nur im „Stickmodus“ ausgeführt werden.

◆ Patronen voor werken met de spoel

U kunt alleen in de borduurstand werken met de spoel.

◆ Patrones para efectos decorativos con bobinas

Los efectos decorativos con bobinas solo pueden realizarse en el "Modo de bordado".

◆ Рисунки для объемного вышивания с помощью устройства для объемного вышивания

Объемную вышивку можно выполнять только в режиме вышивания.

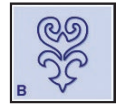

Note : Embroidery patterns for bobbin work are reversed when they have been sewn.

Hinweis : Stickmuster für Bobbin Work werden nach dem Nähen umgedreht.

Remarque : Les motifs de broderie pour le travail à la canette sont inversés lorsqu'ils sont cousus.

Opmerking : Borduurpatronen voor het werken met de spoel worden omgekeerd nadat deze zijn gemaakt.

Nota : I motivi per il ricamo con spolina vengono capovolti durante la cucitura.

Nota : Los patrones de bordado para efectos decorativos con bobinas se invierten una vez cosidos.

Nota : Os padrões de bordado para efeito decorativo com bobina são invertidos quando costurados.

Примечание : Рисунки для объемного вышивания ложатся на нижнюю поверхность изделия.

All of the designs shown in the Bobbin work area are pictured in the machine mirrored or flipped.

Alle Designs, die im Bereich für Bobbin Work angezeigt sind, werden in der Maschine gespiegelt oder umgedreht.

Tous les motifs présentés dans l'aide du travail à la canette sont illustrés dans la machine à l'envers ou retournés.

Alle ontwerpen die in het werkgebied voor de spoel worden weergegeven, worden op de machine gespiegeld of omgeklapt afgebeeld.

Tutti i disegni illustrati nell'area Bobbin work sono raffigurati nella macchina speculari o capovolti.

Todos los diseños mostrados en el área de trabajo de la bobina se muestran en la máquina girados o invertidos.

Todos os desenhos exibidos na área de trabalho da bobina são mostrados na máquina espelhados ou virados.

Все дизайны в разделе объемной вышивки, отображаются в зеркальном или перевернутом виде.

Time is based on the recommended 100spm.
Die Zeit basiert auf den empfohlenen 100 spm.
La durée se base sur la vitesse recommandée de 100 points par minute.
Tijd is gebaseerd op de aanbevolen 100 spm.
Il tempo si basa sulla velocità consigliata di 100 punti/minuto.
El tiempo se basa en las 100 spm recomendadas.
Время рассчитано на основе рекомендованной скорости 100 стежков в минуту.

No.1

3 min
1 (030)
↓ 175.1 mm
↔ 97.0 mm
1.5 m (1.7 yd) (0.9 m + 0.6 m)

Total length of thread needed to sew the pattern (to sew the pattern + to tie ends)
Erforderliche Gesamtfadenlänge zum Nähen des Musters (Muster nähen + Enden verknoten)
Longueur totale de fil nécessaire pour coudre le motif (coudre le motif + nouer les extrémités)
Totale lengte van de draad die nodig is om het patroon te maken (patroon naaien + uiteinden vastknopen)
Lunghezza totale del filo necessaria per la cucitura del motivo (cucire il motivo + annodare le estremità)
Longitud total de hilo necesario para coser el patrón (coser el patrón + atar los extremos)
Comprimento total da linha necessário para costurar o padrão (costurar o padrão + amarrar as pontas)
Общая длина нити, необходимая для вышивания рисунка (вышивание рисунка + связывание концов)

No.2

4 min
1 (509)
↓ 123.6 mm
↔ 127.0 mm
1.6 m (1.8 yd) (1.0 m + 0.6 m)

No.3

10 min
1 (405)
↓ 164.9 mm
↔ 125.0 mm
2.8 m (3.1 yd) (2.2 m + 0.6 m)

No.4

6 min
1 (030)
↓ 196.0 mm
↔ 98.4 mm
2.3 m (2.6 yd) (1.7 m + 0.6 m)

Refer to the operation manual for the sewing machine for details on how to embroider bobbin work patterns.

Weitere Hinweise zum Stickten von Bobbin Work finden Sie in der Bedienungsanleitung der Nähmaschine.

Reportez-vous au Manuel d'instructions de la machine à coudre pour plus de détails sur la broderie des motifs pour le travail à la canette.

Zie de bedieningshandleiding bij de naaimachine voor bijzonderheden over het borduren met de spoel.

Fare riferimento al manuale d'istruzione della macchina da cucire per i dettagli su come ricamare i disegni per il ricamo con spolina.

Para obtener más información sobre cómo bordar patrones para efectos decorativos con bobinas, consulte el manual de instrucciones de la máquina de coser.

Consulte o manual de operação da máquina de costura para saber detalhes sobre como bordar padrões de efeito decorativo com a bobina.

Подробную информацию о вышивании объемных рисунков с помощью устройства для объемного вышивания см. в руководстве пользователя швейной машины.

Embroidery Pattern Color Change Table
Stickmuster-Farbtabelle
Tableau de changement de couleur des motifs de broderie
Kleurwijzigingstabel voor de borduurpatronen
Tabella di cambiamento colori degli schemi di ricamo
Tabla de cambio de color para patrones de bordado
Tabela de alteração de cor do padrão de bordado
Таблицы цветов нитей для вышивок

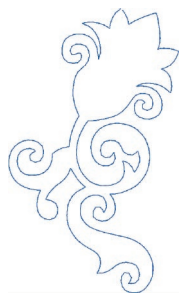

No.5

5 min	
1	(405)
↕	174.8 mm
↔	104.4 mm
 1.8 m (2.0 yd) (1.2 m + 0.6 m)	

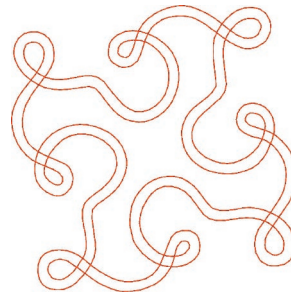

No.10

7 min	
1	(030)
↕	126.2 mm
↔	125.9 mm
 2.4 m (2.7 yd) (1.8 m + 0.6 m)	

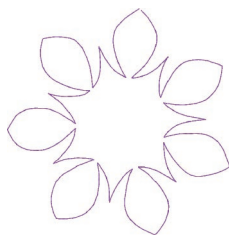

No.6

4 min	
1	(620)
↕	135.5 mm
↔	133.3 mm
 1.6 m (1.8 yd) (1.0 m + 0.6 m)	

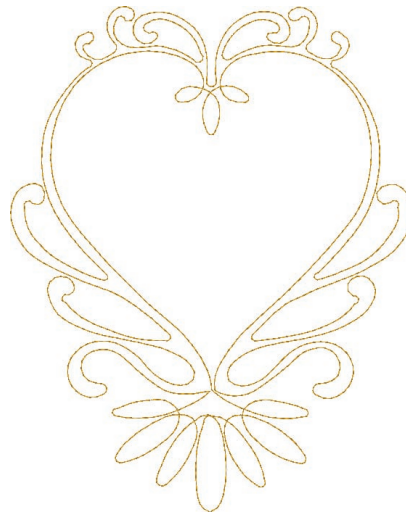

No.11

10 min	
1	(328)
↕	223.5 mm
↔	177.3 mm
 3.5 m (3.9 yd) (2.9 m + 0.6 m)	

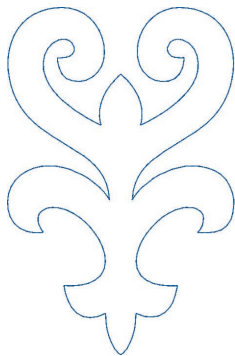

No.7

3 min	
1	(405)
↕	153.9 mm
↔	100.0 mm
 1.6 m (1.8 yd) (1.0 m + 0.6 m)	



No.12

8 min	
1	(542)
↕	123.5 mm
↔	135.5 mm
 2.7 m (3.0 yd) (2.1 m + 0.6 m)	



No.8

2 min	
1	(509)
↕	63.3 mm
↔	75.1 mm
 1.1 m (1.2 yd) (0.5 m + 0.6 m)	



No.9

2 min	
1	(405)
↕	75.0 mm
↔	67.7 mm
 1.0 m (1.1 yd) (0.4 m + 0.6 m)	



No.13

6 min	
1	(209)
↕	81.5 mm
↔	118.3 mm
 2.2 m (2.4 yd) (1.6 m + 0.6 m)	

Examples of Combinations Exemples de combinaisons Esempi di combinazioni Exemplos de combinações

Kombinationsbeispiele Voorbeelden van combinaties Ejemplos de combinaciones Примеры комбинирования

Combine various embroidery patterns, as shown below, to enhance your embroidering enjoyment.
Wenn Sie verschiedene Stickmuster wie unten dargestellt miteinander kombinieren, macht das Stickten noch mehr Spaß.
Combinez plusieurs motifs de broderie comme indiqué ci-dessous, pour un plaisir de broderie garanti.
Zoals hieronder aangegeven kunt u diverse borduurpatronen combineren. Zo borduurt u met nog meer plezier.
Combinare vari disegni da ricamo, come indicato di seguito, per rendere il ricamo ancora più divertente.
Combine distintos patrones de bordado, como se muestra a continuación, para un mayor deleite al bordar.
Combine vários padrões de bordado, como mostrado a seguir, para aprimorar seu passatempo de bordado.
Чтобы получить красивые и оригинальные композиции, можно комбинировать различные рисунки, как это показано ниже.



No.3 x 4



No.9 x 2



No.1 + No.2



No.4 x 2



No.3 + No.4



No.8 × 2

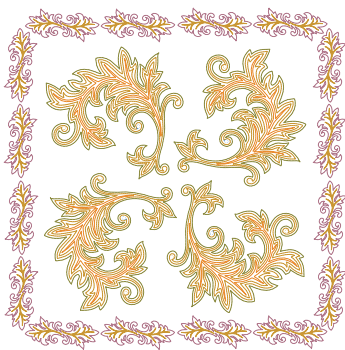
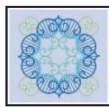

No.1 × 4 + No.2 × 16

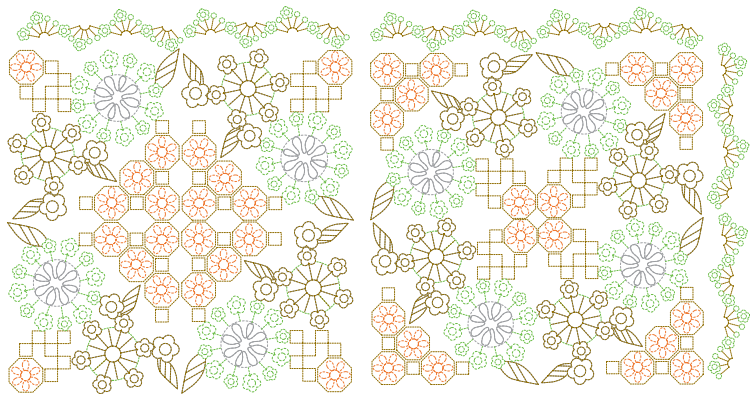

No.4 × 8 + No.5 × 6

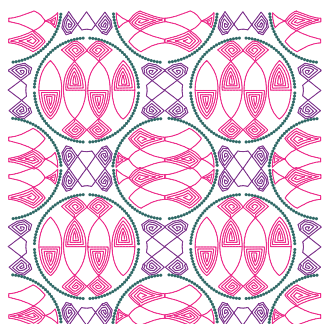

No.10 × 4



◆ 3D combination motifs

◆ Motifs de combinaison 3D

◆ Motivi tridimensionali combinati

◆ Motivos de combinações 3D

◆ 3D-Kombinationsmotive

◆ 3D-combinatiemotieven

◆ Motivos de combinación 3D

◆ Комбинированные 3D вышивки

How to make 3D combination motifs

1. Use the same color of thread in the bobbin and on top for the designs.
2. Embroider individual shapes. When sections are completed they are joined to make dimensional shapes. Use a thread or narrow ribbon of a complimentary color to join them.

 When embroidering on organza, tulle or similar fabrics, hoop together a single layer of water-soluble stabilizer with the fabric to be embroidered. When the embroidery process is complete, remove from the hoop and thoroughly rinse embroidered piece in warm water. Dry until the piece is slightly damp, shape by hand or with cool iron. When dry, trim edges.

 The following are things you should be aware of when using water-soluble sheets without any fabric. When embroidering these designs, please use three layers of water-soluble sheets. Remember to check that you have enough upper thread and lower thread for the design. If the thread breaks during embroidery, back up at least 10 stitches before starting again. If your embroidery machine has a speed reduction feature, select the lowest speed. When dissolving the water-soluble sheet, cut off the unnecessary portions and wash the embroidered piece in warm water until it no longer feels slippery. After the final rinse, dry the embroidery motif until slightly damp, shape by hand or with a cool iron, allow to dry completely.

Comment réaliser des combinaisons de motifs 3D

1. Utilisez la même couleur de fil dans la bobine et sur le dessus pour les motifs.
2. Brodez les formes séparément. Lorsque les différentes parties sont complètes, elles sont jointes pour créer des formes en volume. Utilisez un fil ou un ruban étroit d'une couleur complémentaire pour les joindre.

 Lorsqu'il s'agit d'une broderie sur de l'organza, du tulle ou des tissus similaires, cercelez ensemble une seule couche de stabilisateur hydrosoluble et le tissu à broder. Lorsque l'étape de broderie est terminée, décernez et rincez soigneusement la pièce brodée à l'eau tiède. Faites sécher jusqu'à ce que la pièce soit légèrement humide avant de lui donner sa forme à la main ou avec un fer à repasser froid. Une fois qu'elle est complètement sèche, coupez les bords.

 Voici ci-dessous les points que vous devez considérer lorsque vous utilisez uniquement des feuilles solubles dans l'eau pour la broderie sans aucun tissu. Lorsque vous brodez ces motifs, veuillez utiliser trois couches de feuilles hydrosolubles. Assurez-vous de bien vérifier que vous avez assez de fil supérieur et de fil inférieur pour le motif. Si le fil casse au cours de la broderie, consolidez au moins 10 points avant de recommencer. Si votre machine à broder est équipée d'une fonction de réduction de la vitesse, veuillez choisir la vitesse la plus lente. Lors de la dissolution de la feuille hydrosoluble, coupez les parties inutiles et lavez la pièce brodée à l'eau tiède jusqu'à ce qu'elle ne soit plus glissante. Après le rinçage final, séchez le motif de broderie jusqu'à ce qu'il ne soit plus que légèrement humide, donnez-lui sa forme à la main ou avec un fer à repasser froid avant de le laisser sécher complètement.

Come creare motivi tridimensionali combinati

1. Per la parte superiore nei disegni usare lo stesso colore di quello del rochetto.
2. Ricamare le forme individualmente. Una volta completate le sezioni le si può unire per creare forme dimensionali. Per l'unione si suggerisce di usare un filo o un nastro stretto del colore desiderato.

 Durante il ricamo su organza, tulle o tessuti simili è opportuno cerchiare con il tessuto da ricamare un singolo strato di stabilizzante solubile in acqua. Al termine del ricamo si dovrà quindi rimuovere il cerchio e risciacquare bene il pezzo ricamato in acqua calda. Lasciare asciugare sino a quando rimane solo lievemente umido e dare quindi la forma desiderata a mano o con un ferro da stiro freddo. Una volta asciutto tagliare i bordi.

 In caso d'uso di pellicole solubili in acqua per ricamo senza tessuto occorre essere consapevoli dei seguenti aspetti: Per ricamare quei disegni si suggerisce di usare tre strati di pellicola solubile in acqua. Ricordarsi di accertarsi di disporre di filo superiore e inferiore a sufficienza per il disegno. Se durante il ricamo il filo si spezza, prima di riprendere a ricamare tornare indietro almeno dieci punti. Se la propria macchina da cucire dispone della funzione di regolazione della velocità occorre selezionare la più bassa. Durante lo scioglimento della pellicola solubile in acqua occorre rimuovere le parti non necessarie e risciacquare il ricamo in acqua calda sino a quando cessa di essere viscido. Dopo il risciacquo finale il motivo ricamato andrà lasciato asciugare sino a quando rimarrà lievemente umido, quindi gli si darà la forma desiderata a mano o con un ferro da stiro freddo lasciandolo poi asciugare completamente.

Anfertigen von 3D-Kombinationsmotiven

1. Verwenden Sie für die Muster Faden derselben Farbe in der Spule und oben.
2. Sticken Sie die einzelnen Formen. Die fertigen Abschnitte werden zusammengefügt, um plastische Formen zu schaffen. Verwenden Sie zum Zusammenfügen ein Garn oder schmales Band in einer passenden Farbe.

 Beim Sticken auf Organza, Tüll oder ähnlichen Stoffen spannen Sie eine einzelne Lage wasserlösliche Folie mit dem zu bestickenden Stoff in den Rahmen. Nach dem Sticken nehmen Sie die Stickarbeit aus dem Rahmen und spülen sie gründlich mit warmem Wasser. Lassen Sie die Arbeit trocknen, bis sie nur leicht feucht ist, und formen Sie sie von Hand oder mit einem kalten Bügeleisen aus. Sobald sie trocken ist, schneiden Sie die Kanten gerade.

 Die folgenden Punkte sind zu beachten, wenn für eine Stickarbeit nur wasserlösliche Folie ohne Stoff verwendet wird. Verwenden Sie beim Sticken solcher Muster bitte drei Lagen wasserlösliche Folie. Achten Sie darauf, dass ausreichend Ober- und Unterfaden für das Muster vorhanden ist. Sollte der Faden beim Sticken reißen oder ausgehen, gehen Sie zum Weitersticken mindestens 10 Stiche zurück. Falls Ihre Stickmaschine eine Geschwindigkeitsregelung hat, wählen Sie die langsamste Stufe. Zum Öffnen der wasserlöslichen Folie schneiden nicht benötigte Teile ab und waschen die Stickarbeit in warmem Wasser aus, bis sie sich nicht mehr schlüpfrig anfühlt. Nach dem letzten Spülvorgang lassen Sie das Stickmotiv trocknen, bis es leicht feucht ist, formen es von Hand oder mit einem kalten Bügeleisen aus, und lassen es dann vollständig trocknen.

Hoe maak ik 3D Combinatiemotiefjes

1. Gebruik dezelfde kleur draad in de spoel en aan de bovenkant voor elk ontwerp.
2. Borduur afzonderlijke vormen. Als alle onderdelen klaar zijn worden ze bij elkaar gevoegd om dimensionale vormen te maken. Gebruik draad of lint van een gepaste kleur om de onderdelen samen te voegen.

 Wanneer U borduurt op organza, tule of soortgelijk textiel, verbind dan een enkele laag wateroplosbare stabilisator met het te borduren textielwerk. Wanneer het borduurproces compleet is, verwijder dan het borduurwerk van de stabilisator en was het grondig in warm water. Laat het drogen tot het nog licht vochtig is en geef het daarna vorm met de hand of met een koud strijkijzer. Wanneer het volledig droog is kunt U de randjes bijknippen.

 Als U alleen wateroplosbaar papier gebruikt voor het borduren zonder textiel, dient U de volgende dingen in acht te houden. Indien U die onderwerpen borduurt, gebruik dan drie lagen van het wateroplosbare papier. Vergeet niet van tevoren vast te stellen dat U genoeg bovendraad en onderdraad voor het ontwerp heeft. Mocht de draad breken tijdens het borduren, ga dan minstens 10 steken terug voordat U weer opnieuw begint. Als uw borduurmachine een functie voor snelheidsreductie heeft, kies dan de laagst mogelijke snelheid. Wanneer U het wateroplosbare papier oplost, verwijder de onnodige delen en was het borduurwerk in warm water tot het niet meer glad aanvoelt. Laat na de laatste spoelbeurt het borduurmotief drogen tot het licht vochtig is, vorm het vervolgens met de hand of met een koud strijkijzer, en laat het volledig drogen.

Cómo realizar motivos de combinación 3D

1. Utilice el mismo color de hilo en la bobina y en la parte superior para los diseños.
2. Borde talles individuales. Cuando se finalizan las secciones, se juntan para componer talles dimensionales. Utilice un hilo o una cinta estrecha de color complementario para unirlos.

 Cuando borde en organza, tul, o tejidos similares, ciña juntas una sola capa de estabilizador soluble en agua con la tela que vaya a bordar. Cuando finalice el proceso de bordado, elimine el del tejido y enjuague completamente la pieza bordada en agua caliente. Seque la pieza hasta que esté ligeramente húmeda, y déle forma con la mano o con un plancha. Cuando esté seca, recorte los bordes.

 A continuación se indica lo que usted deberá tener en cuenta cuando utilice solamente láminas solubles en agua para bordar sin ninguna tela. Cuando borde tales diseños, utilice tres capas de láminas solubles en agua. No se olvide de comprobar si tiene hilo superior e inferior para el diseño. Si el hilo se rompe durante el bordado, vuelva atrás 10 puntadas por lo menos antes de comenzar de nuevo. Si su máquina de bordar posee función de reducción de velocidad, seleccione la velocidad más baja. Cuando disuelva la lámina soluble en agua, corte las partes innecesarias, y lave la pieza bordada en agua caliente hasta que deje de notarse resbaladiza. Después del lavado final, seque el adorno bordado hasta que esté ligeramente húmedo, déle forma con la mano o con un plancha fría, y deje que se seque completamente.

Como fazer motivos de combinações 3D

1. Use a mesma cor de linha na bobina e na parte superior para os desenhos.
2. Borda formas individuais. Quando as seções estão completas, são unidas para criar formas dimensionais. Use uma linha ou fita estreita de uma cor complementar para uni-las.

 Ao bordar em organza, tulle ou tecidos similares, envolva uma camada única de entretela solúvel em água no tecido a ser bordado. Quando o processo do bordado estiver completo, remova da área envolvida e lave totalmente a peça bordada na água quente. Seque até que a peça fique um pouco úmida, faça a forma manualmente ou com o ferro frio. Quando estiver seco, corte as bordas.

 O conteúdo sobre o qual você deverá estar ciente ao usar folhas solúveis em água sem nenhum tecido é apresentado a seguir. Ao bordar esses desenhos, use três camadas de folhas solúveis em água. Lembre-se de certificar-se de que há quantidade suficiente de linhas, superior e inferior, para o desenho. Se a linha se romper durante o bordado, volte pelo menos 10 pontos antes de começar novamente. Se sua máquina de bordar tiver um recurso de redução de velocidade, selecione a velocidade mínima. Ao dissolver a folha da entretela solúvel em água, retire as partes desnecessárias e lave a peça bordada em água morna até que não fique mais escorregadia. Após o enxágue final, seque o motivo de bordado até que fique um pouco úmido, faça a forma manualmente ou com o ferro frio e deixe secar completamente.

No.6 x 6

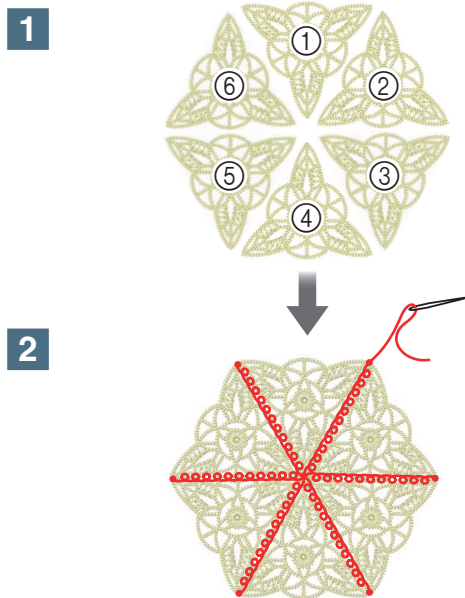

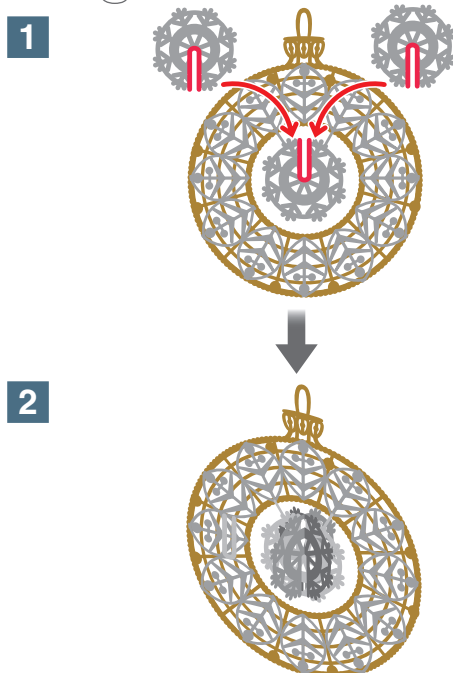

No.12



Создание комбинированной 3D вышивки

1. Используйте нити одного цвета в шпульке и на лицевой стороне рисунка.
2. Вышейте отдельные фигуры. После завершения вышивания отдельных частей получатся объемные фигуры. Для их соединения используйте нить или узкую ленту подходящего цвета.

 Когда вышивка осуществляется на органзе, тюле или похожих материалах, запыляйте вместе одинарный слой водорастворимого стабилизатора и сам материал, на котором необходимо сделать вышивку. Когда вышивка закончена, снимите пяльцы и тщательно промойте изделие в теплой воде. Высушите изделие до слегка влажного состояния, затем расправьте руками или негорячим утюгом. Когда изделие окончательно высохнет, обрежьте края.

 При использовании водорастворимых листов без материала необходимо учитывать следующее. При вышивании таких дизайнов используйте водорастворимые листы в три слоя. Не забудьте проверить, что для вышивания имеется достаточно верхней и нижней нити. Если нить порвется во время вышивания, перед продолжением вышивания вернитесь как минимум на 10 стежков назад. Если на вышивальной машине имеется функция снижения скорости, выберите самую низкую скорость. При растворении водорастворимого листа обрежьте ненужные части листа и промывайте вышивку теплой водой до тех пор, пока она не перестанет быть скользкой на ощупь. Затем окончательно промойте вышитое изделие, высушите его так, чтобы оно было немного влажным, придайте ему форму рукой или негорячим утюгом и дайте окончательно высохнуть.

No.13 x 3

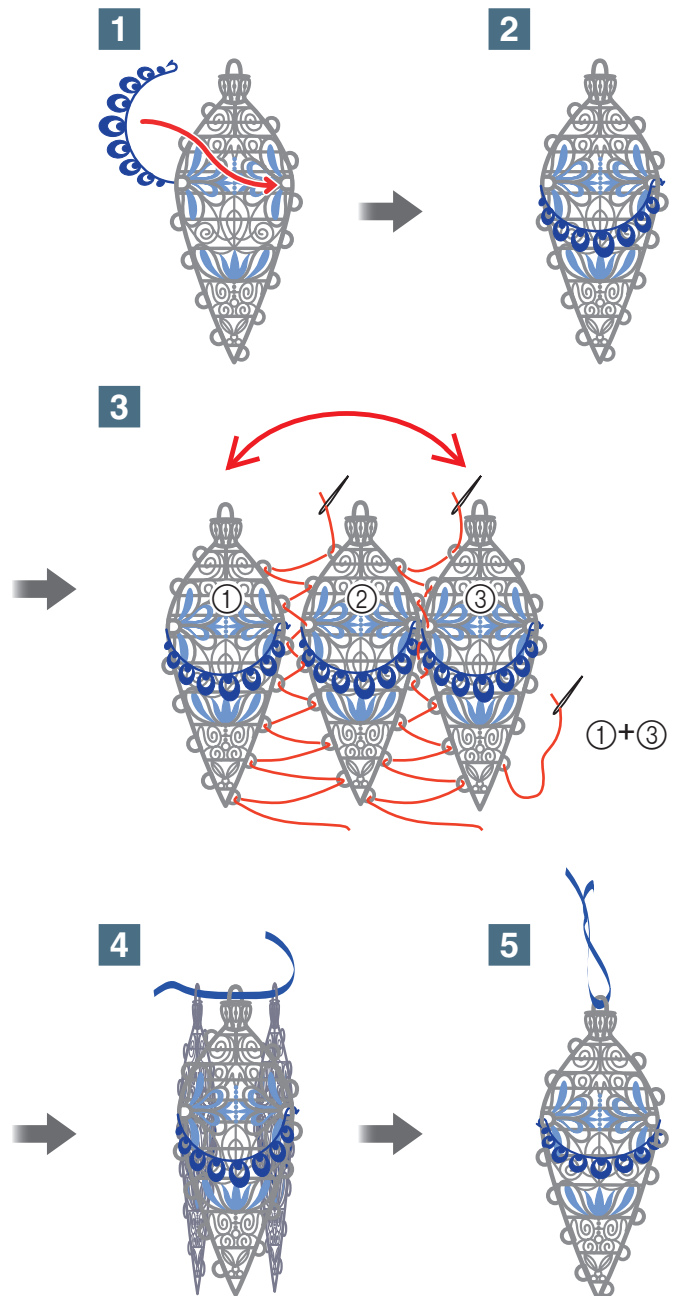

No.14 

A



No.14 x 9 

B

1

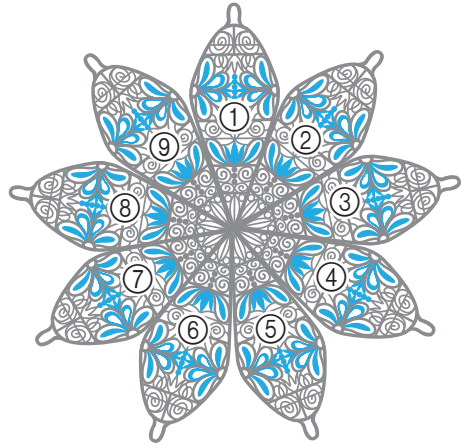

2

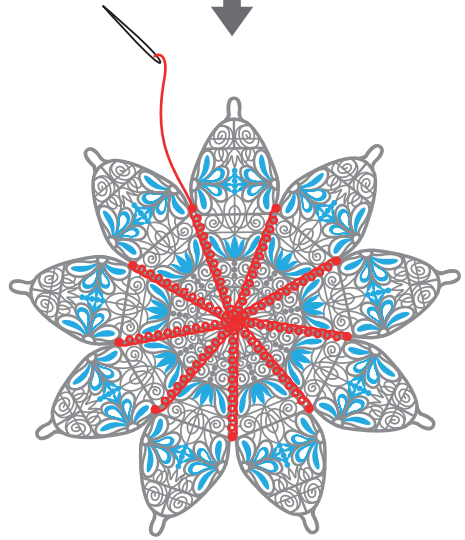

No.15 

1

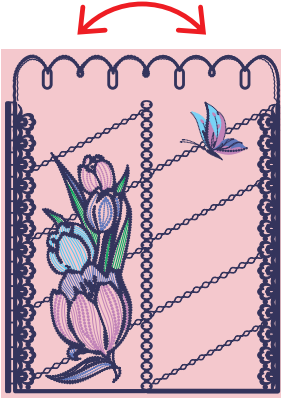

2

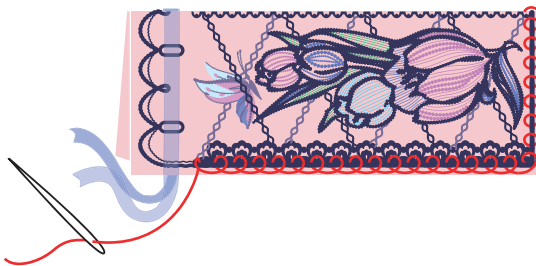

3

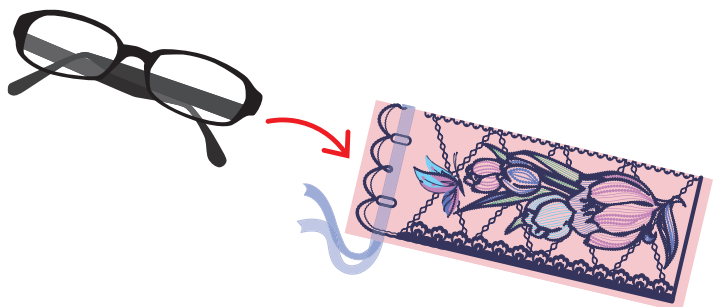

Color Thread Conversion Chart

Tableau de conversion des fils de couleur

Tabella di conversione dei fili colorati





































Tabela de conversão das cores de linha













































Stickgarn-Farbtabelle

Omzettingstabel voor kleurgaren

Tabla de conversión de hilos de color

Таблица преобразования цветов нитей

	Color Name / Name der Farbe / Nom de la couleur / Kleur naam / Nome del colore / Nombre de color / Nome da cor / Наименование цвета	Embroidery	Country	Madeira Polyneon	Madeira Rayon	Sulky	R.A. Polyester
1	Black / Schwarz / Noir / Zwart / Nero / Negro / Preto / Черный	 900	 100	1800	1000	1005	5596
2	White / Weiss / Blanc / Wit / Bianco / Blanco / Branco / Белый	 001	 000	1801	1002	1001	5597
3	Red / Rot / Rouge / Rood / Rosso / Rojo / Vermelho / Красный	 800	 149	1637	1037	1037	5678
4	Pink / Rosa / Rose / Rose / Rosa / Rosado / Cravo / Розовый	 085	 155	1921	1108	1224	5523
5	Deep Rose / Tiefrot / Rose foncé / Roserood / Rosa Intenso / Rosa Intenso / Rosa-carregado / Темно-розовый	 086	 024	1721	1117	1154	9168
6	Flesh Pink / Fleischfarben / Rose chair / Lichtrose / Rosa Carne / Rosa Claro / Rosa pêssego / Свежий розовый	 124	 152	1915	1015	1064	5677
7	Dark Fuchsia / Dunkelviolett / Fuchsia foncé / Donker Fuchsia Paars / Fuchsia Scuro / Fuchsia Oscuro / Vermelho fu csia escuro / Цвет темной фуксии	 107	 126	1984	1383	1533	5804
8	Vermillion / Zinnoberrrot / Vermillion / Vermil Joen / Rosso Vermiglio / Bermellon / Vermelhão / Багряный	 030	 148	1779	1179	1184	9023
9	Carmine / Karminrot / Carmin / Karmijn / Rosso Carminio / Carmin / Carmim / Карминный	 807	 158	1986	1081	1511	5561
10	Royal Purple / Königsapur / Pourpre royal / Dieppaars / Rosso-Violaceo / Violeta Real / Púrpura real / Яркий пурпурный	 869	 636	1788	1188	1192	5681
11	Magenta / Magenta / Magenta / Magenta / Magenta / Magenta / Фуксин	 620	 625	1710	1319	1191	5592
12	Salmon Pink / Lachsrosa / Rose saumon / Zalmrose / Rosa Salmone / Rosa Salmon / Cravo salmão / Оранжево-розовый	 079	 122	1816	1317	1225	5773
13	Amber Red / Bernsteinrot / Rouge ambre / Amber Rood / Rosso Ambra / Rojo Ambar / Vermelho-âmbar / Янтарно-красный	 333	 212	1942	1341	1119	5591
14	Lemon Yellow / Zitronengelb / Jaune citron / Citro Engeel / Giallo Limone / Amarillo Limon / Amarelo limão / Лимоновожелтый	 202	 342	1623	1023	1067	5625
15	Yellow / Gelb / Jaune / Geel / Giallo / Amarillo / Amarelo / Желтый	 205	 043	1980	1068	1187	5860
16	Harvest Gold / Erntegold / Or blé / Oogst Kleurig Goud / Giallo Grano / Amarillo Trigo / Ouro trigo / Желтозолотистый	 206	 334	1971	1024	1124	5770
17	Orange / Orange / Orange / Oranje / Arancio / Naranja / Laranja / Оранжевый	 208	 335	1951	1137	1024	5694
18	Pumpkin / Kürbisgelb / Citrouille / Pompoen / Giallo Zucca / Calabaza / Abóbora / Тыквенный	 126	 322	1952	1155	1065	5630
19	Tangerine / Mandarinenorange / Tangerine / Felorange / Mandarino / Tangerina / Tangerina / Мандаринный цвет	 209	 336	1965	1078	1078	5518
20	Cream Brown / Braun Weiss / Brun crème / Creme Bruin / Nocciola / Marron Crema / Marrom creme / Кремовый	 010	 331	1866	1022	1061	5761
21	Cream Yellow / Gelblich Weiss / Jaune crème / Cremegeel / Giallo Crema / Amarillo Crema / Amarelo creme / Кремово-желтый	 812	 370	1861	1349	1135	5564
22	Khaki / Khakibraun / Kaki / Khaki / Kaki / Caqui / Caqui / Цвет хаки	 348	 242	1939	1255	1055	5636
23	Deep Gold / Tiefgold / Or foncé / Diepgoud / Oro Scuro / Amarillo Oro / Ouro velho / Глубокий золотой	 214	 354	1772	1172	1025	5770
24	Brass / Messingfarben / Cuivre / Koper / Ottone / Bronze / Latão / Цвет латуни	 328	 404	1791	1192	1159	9109
25	Linen / Leinen Farbig / Drap / Linnen / Lino / Lino / Linho / Льняной	 307	 025	1682	1149	1082	5635
26	Dark Brown / Dunkelbraun / Brun sombre / Donker Bruin / Marrone Scuro / Marron Oscuro / Marrom escuro / Темно-коричневый	 058	 717	1859	1130	1129	5637
27	Reddish Brown / Rotbraun / Brun rougeâtre / Rossing Bruin / Marrone Bruciato / Marron Rojizo / Marrom-avermelhado / Краснокоричневый	 337	 264	1753	1253	1021	5781
28	Clay Brown / Lehmbraun / Brun argile / Kleibruin / Marrone Argilla / Marron Tierra / Marrom barro / Коричневый	 339	 224	1621	1021	1158	5590
29	Beige / Beige / Beige / Beige / Beige / Beige / Bege / Бежевый	 843	 012	1738	1138	1127	5598
30	Warm Gray / Warmgrau / Gris vif / Warm Grijs / Grigio Caldo / Gris Caliente / Cinzento-quente / Теплый серый	 399	 706	1860	1085	1218	9126
31	Russet Brown / Rotbraun / Brun roussâtre / Roodbruin / Ruggine / Marron Bermejo / Marrom ruivo / Желтокоричневый	 330	 414	1726	1194	1126	5702
32	Light Brown / Hellbraun / Brun clair / Licht Bruin / Marrone Chiaro / Marron Claro / Marrom claro / Светло-коричневый	 323	 255	1729	1056	1128	5789
33	Seacrest / Blassgrün / Vert Pale / Blauw Groen / Cresta Di Mare / Verde Celadon / Azul marinho / Серо-голубой	 542	 505	1647	1219	1077	5578
34	Mint Green / Pfefferminzgrün / Vert menthe / Munt Groen / Verde Menta / Verde Menta / Verde hortelã / Мятный зеленый	 502	 461	1702	1302	1047	5511
35	Leaf Green / Blattgrün / Vert feuille / Bladgroen / Verde Prato / Verde De Hoja / Verde folha / Цвет зеленой лиспы	 509	 463	1749	1050	1510	5514
36	Olive Green / Olivgrün / Vert olive / Olif Groen / Verde Oliva / Verde Oliva / Verde oliva / Зеленый оливковый	 519	 476	1904	1396	1174	5502
37	Dark Olive / Dunkelolivgrün / Olive foncé / Donker Olijf / Oliva Scuro / Verde Oliva Oscuro / Verde-oliva escuro / Темно-оливковый	 517	 473	1769	1156	1156	9122
38	Teal Green / Blaugrün / Vert sarcelle / Taling Groen / Verde Anatra / Verde Azulado / Azul turquesa / Зеленый чирка	 534	 483	1879	1298	1503	5751
39	Emerald Green / Emerald Grün / Vert émeraude / Smaragd Groen / Verde Smeraldo / Verde Esmeralda / Verde-esmeralda / Изумрудный	 507	 485	1750	1250	1079	5508

	Color Name / Name der Farbe / Nom de la couleur / Kleur naam / Nome del colore / Nombre de color / Nome da cor / Наименование цвета	Embroidery	Country	Madeira Polyneon	Madeira Rayon	Sulky	R.A. Polyester
40	Deep Green / Dunkelgrün / Vert foncé / Diepgroen / Verde Intenso / Verde Intenso / Verde-carregado / Темно-зеленый	 808	 467	1703	1370	1208	5615
41	Fresh Green / Frischgrün / Vert frais / Licht Groen / Verde Mela / Verde Fresco / Verde-fresco / Цвет свежей зелени	 027	 442	1706	1102	1209	9153
42	Lime Green / Limonengrün / Vert tilleul / Limoen Groen / Verde Tiglio / Verde Lima/ Verde lima / Лаймовый зеленый	 513	 444	1848	1049	1177	5622
43	Moss Green / Moosgrün / Vert mousse / Mosgroen / Verde Muschio / Verde Musgo / Verde musgo / Серозеленый	 515	 446	1770	1369	1176	9091
44	Blue / Blau / Bleu / Blauw / Azzurro / Azul / Azul / Синий	 405	 586	1829	1177	1076	5684
45	Ultra Marine / Ultra Marin / Outremer / Ultra Marijn / Blu Oltremare / Azul De Ultramar / Azulultra-marinho / Ультрамарин	 406	 575	1842	1076	1042	5736
46	Light Blue / Hellblau / Bleu clair / Licht Blauw / Celeste / Azul Claro / Azulclaro / Светло-голубой	 017	 150	1932	1132	1074	5683
47	Sky Blue / Himmelblau / Bleu ciel / Hemels Blauw / Azzurro Cielo / Celeste / Azul celeste / Лазурь	 019	 512	1828	1029	1196	5506
48	Electric Blue / Elektrischblau / Bleu électrique / Staal Blauw / Blu Elettrico / Azul Electrico / Azul eléctrico / Электрик	 420	 564	1797	1297	1250	5829
49	Peacock Blue / Pfauenblau / Bleu paon / Pauwen Blauw / Blu Pavone / Azul Pavo Real / Azul pavão / Переличатый синий	 415	 057	1652	1252	1206	5810
50	Prussian Blue / Berliner Blau / Bleu de Prusse / Pruisisch Blauw / Blu De Prussia / Azul De Prusia / Azul da prússia / Берлинская лазурь	 007	 588	1767	1166	1535	5737
51	Cornflower Blue / Kornblumenblau / Bleu centauree / Koren Bloemen Blauw / Blu Fior-Daliso / Azul Centaura / Azul suave / Васильковый	 070	 015	1830	1335	1028	5601
52	Light Lilac / Helllila / Lilas clair / Licht Lila / Lilla Chiaro / Lila Suave / Lilás claro / Светло-сиреневый	 810	 133	1911	1031	1121	9016
53	Lilac / Lila / Lilas / Lila / Lilla / Lila / Lilás / Сиреневый	 612	 623	1831	1080	1080	9009
54	Violet / Violet / Violet / Violet / Violetto / Violeta / Violeta / Фиолетовый	 613	 624	1631	1033	1194	5588
55	Purple / Purpur / Pourpre / Paars / Viola / Purpura / Púrpura / Пурпурный	 614	 635	1880	1122	1122	5554
56	Lavender / Lavendel / Lavande / Lavendel / Lavenda / Lavanda / Lavanda / Лавандовый	 804	 604	1630	1261	1193	5586
57	Wisteria Violet / Wistaria Violet / Violet glycine / Blauwe Regen Paars / Glicine / Violeta Vistaria / Violeta-licinia / Цвет глицинии	 607	 003	1943	1311	1032	5587
58	Pewter / Zinngrau / Étain / Tinkleurig / Peltro / Peltre / Estanho / Цвет пьютера	 704	 745	1840	1041	1041	9114
59	Dark Gray / Dunkelgrau / Gris somber / Donker Grijs / Grigio Scuro / Gris Oscuro / Cinzento-escuro / Темно-серый	 707	 747	1841	1241	1220	5565
60	Silver / Silber / Argent / Zilver / Argento / Plata / Prata / Серебряный	 005	 020	1812	1087	1011	5640
61	Gray / Grau / Gris / Grijs / Grigio / Gris / Cinzento / Серый	 817	 734	1640	1118	1219	5782
62	----->						
63	-----						
64							
65	NOT DEFINED / NICHT DEFINIERT / NON DEFINI / NIET GEDEFINIEERD / NON DEFINITO / SIN DEFINIR / NÃO DEFINIDO / НЕ ОПРЕДЕЛЕНО						

- Note:** *The conversion chart is based on Embroidery thread. The color shades may vary with the different brands listed on the chart. If unsure of a particular color(s), please sew test. Robison Anton (R.A.), Madeira and Sulky are respectively registered trademarks. Actual colors may vary slightly from the chart.*
- Hinweis:** *Die Umrechnungstabelle basiert auf dem Stickgarn. Die Farbschattierungen können je nach unterschiedlichen, in der Tabelle aufgeführten Marken abweichen. Wenn Sie sich bei bestimmten Farben nicht sicher sind, nähen Sie bitte zur Probe. Robison Anton (R.A.), Madeira und Sulky sind eingetragene Warenzeichen. Die tatsächlichen Farben können leicht von der Tabelle abweichen.*
- Remarque:** *Le tableau de conversion est basé sur le fil de broderie. Les nuances de couleur peuvent varier en fonction des marques énumérées dans le tableau. En cas de doute sur un coloris, faites un essai de couture. « Robison Anton (R.A.) », « Madeira » et « Sulky » sont des marques déposées respectives. Les couleurs réelles risquent d'être légèrement différentes de celles du tableau.*
- Opmerking:** *Het omzettingsschema is gebaseerd op het gebruik van borduurzijde. De kleurtinten kunnen ietwat verschillen voor de diverse merken in het schema. Bent u niet zeker bent van de juiste kleur(en), borduur dan een stukje op proef. De namen Robison Anton (R.A.), Madeira en Sulky zijn allemaal gedeponeerde handelsmerken. De feitelijke kleurtinten kunnen iets afwijken van het getoonde schema.*
- Nota:** *La tabella di conversione è in funzione del filo da ricamo. Le tonalità cromatiche possono variare secondo le differenti marche elencate nella tabella. In caso di dubbio su un particolare colore o su più colori si raccomanda di eseguire una prova di cucito. Robison Anton (R.A.), Madeira e Sulky sono marchi di fabbrica registrati. I colori effettivi possono variare lievemente rispetto a quelli della tabella.*
- Nota:** *La tabla de conversión está basada en hilo de bordar. Los tonos de color podrán variar con las diferentes marcas enumeradas en la tabla. Si tiene dudas sobre un color o colores en particular, haga un cosido de prueba. Robison Anton (R.A.), Madeira y Sulky son marcas registradas respectivamente. Los colores verdaderos podrán variar ligeramente con respecto a los de la tabla.*
- Nota:** *A tabela de conversão é baseada na linha de bordar. Os matizes das cores podem variar nas diferentes marcas listadas na tabela. Se não tiver certeza de uma cor em particular ou mais, faça o teste de costura. Robison Anton (R.A.), Madeira e Sulky são respectivamente marcas registradas. As cores reais podem variar um pouco da tabela.*
- Примечание:** *Таблица преобразования составлена на базе вышивальных нитей. Оттенки цветов могут варьироваться в зависимости от производителей, указанных в таблице. Если вы не уверены в выборе какого-то конкретного цвета, произведите пробную вышивку. Robison Anton (R.A.), Madeira и Sulky являются зарегистрированными товарными знаками. Реальные цвета могут несколько отличаться от представленных в таблице.*

English
German
French
Dutch
Italian
Spanish
Portuguese-BR
Russian

882-D82
Printed in Taiwan



XF3637-001